

GTF Hygienic Linear Actuator Catalog

January 10, 2025 | PN85645

**CURTISS -
WRIGHT**

EXLAR®

Specifications

Drawings

Ordering

And More...



**Integrated Electric Motor | Actuator
for Food & Beverage**

Featuring the New Hygienic Sealing System

Power | Precision | Proven

Table of Contents

GTF Series	3
Product Features	4
GTF Hygienic Seal System	5
GTF Configuration Options	6
General Specifications	7
Material Specifications	7
Mechanical Specifications	8
Electrical Specifications	10
Speed vs. Force Curves	13
Options	16
Dimensions	17
Feedback Types for GTF	23
Wiring and Alignment Options	24
Ordering Information	37
Warranty and Limitations of Liability	38

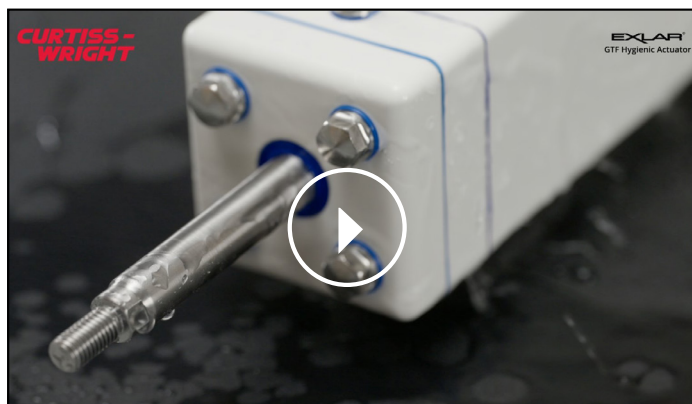
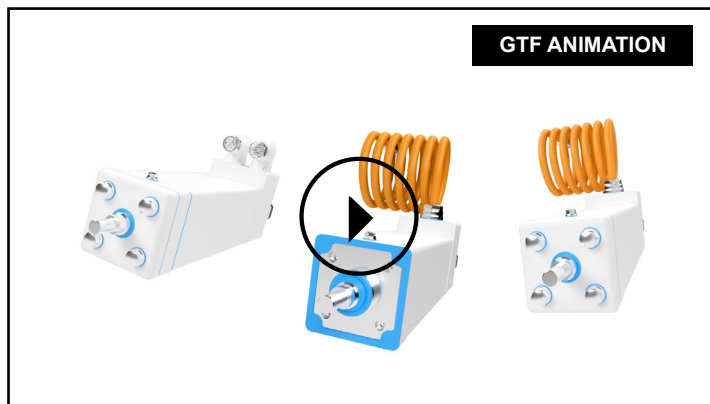

GTF Series

Description

The GTF Series extends Exlar's popular high-force GTX linear actuators into applications that require hygienic machines in Food & Beverage, Packaging, and Pharmaceutical automation systems.

The GTF Series offers flexible solutions coupled with low maintenance features and proven reliability. The GTF food grade actuator mirrors the performance of Curtiss-Wright's standard Exlar GTX actuators and incorporates features to make it easier for machines to achieve hygienic certifications like USDA, 3-A, BISSC, EHEDG, and NSF.

BENEFITS

- Smooth surfaces and FDA approved white epoxy paint reduces cleaning time and insures machine certification
- A stainless-steel main rod provides corrosion resistance nearest to food contact zones
- Different face mount and clevis mount versions of the GTF actuator make it easier to meet hygienic design guidelines with different mounting configurations
- Food grade grease and seal materials eliminate contamination of food products
- Designed to meet 3-A and EHEDG Guidelines
- Long, robust actuator life due to Exlar inverted roller screw technology
- Single or two cable connection for motor power and feedback
- Standard IP67 and optional IP69K environmental ratings

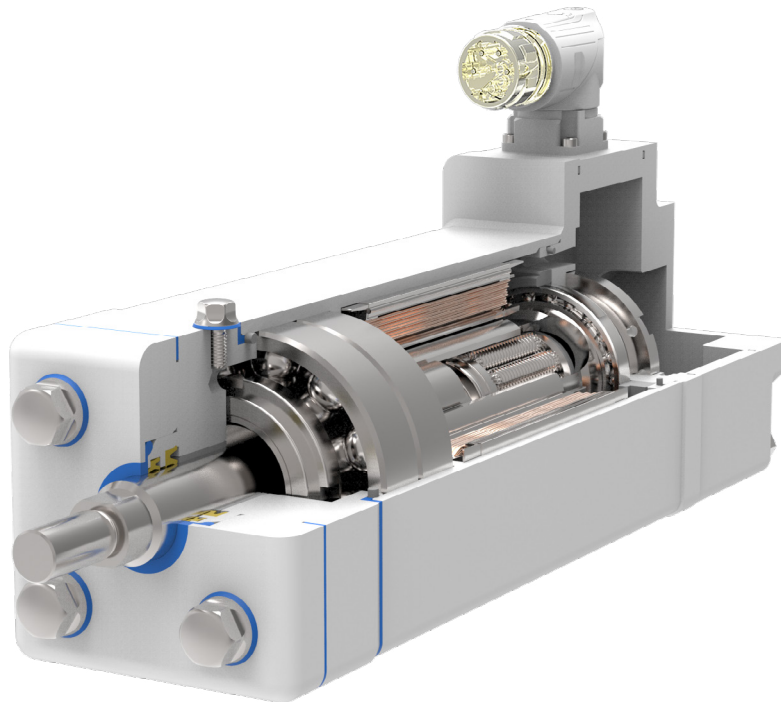

Product Features

Face Mount Configuration

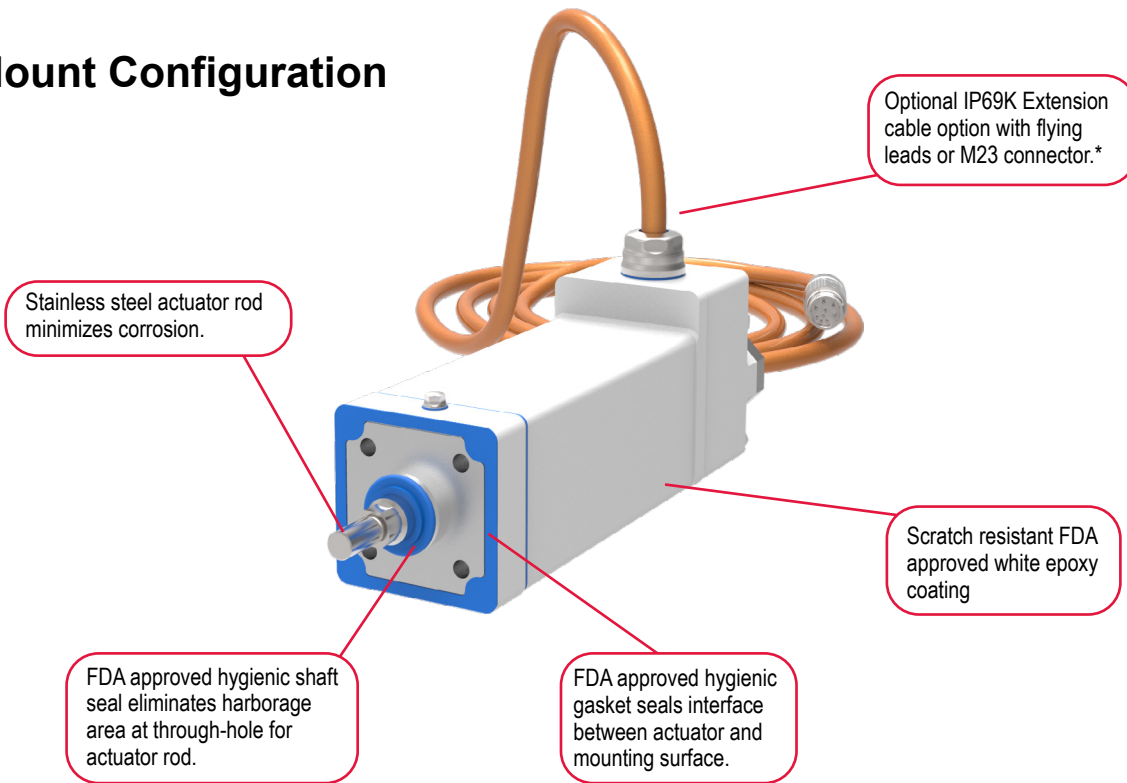

*Only available with certain feedback types

Clevis Mount Configuration

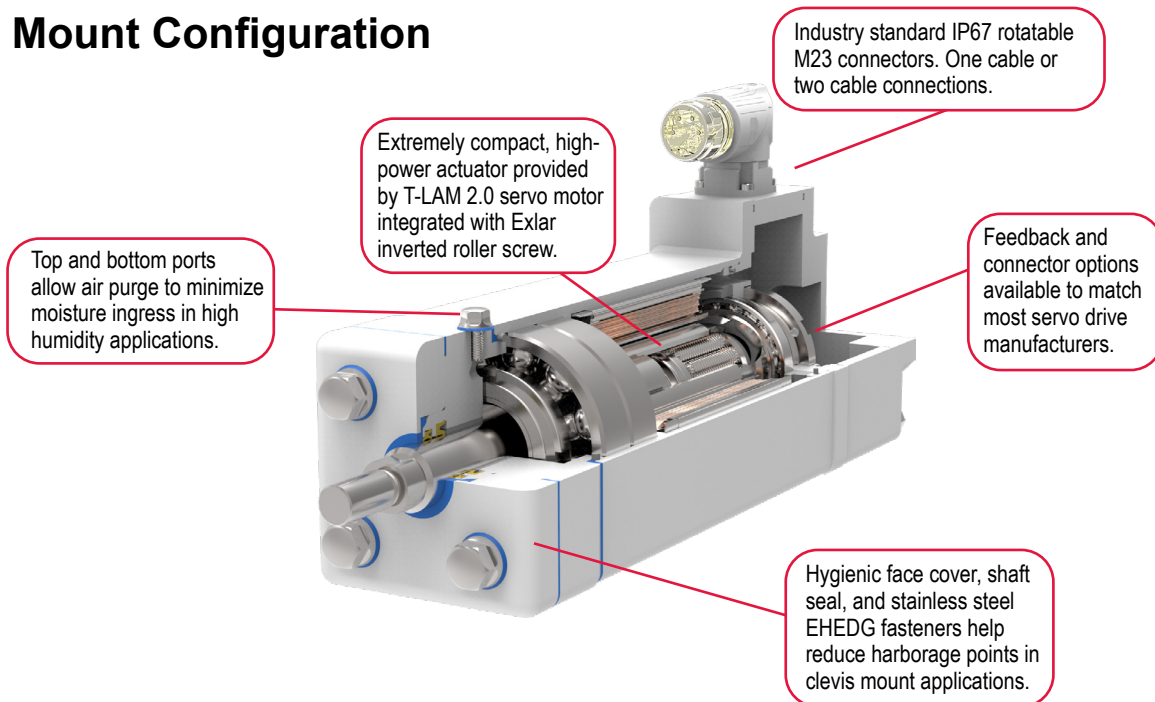

GTF Hygienic Seal System

Making it easier to seal around the actuator thrust rod and mounting surfaces

Face Mount Configuration

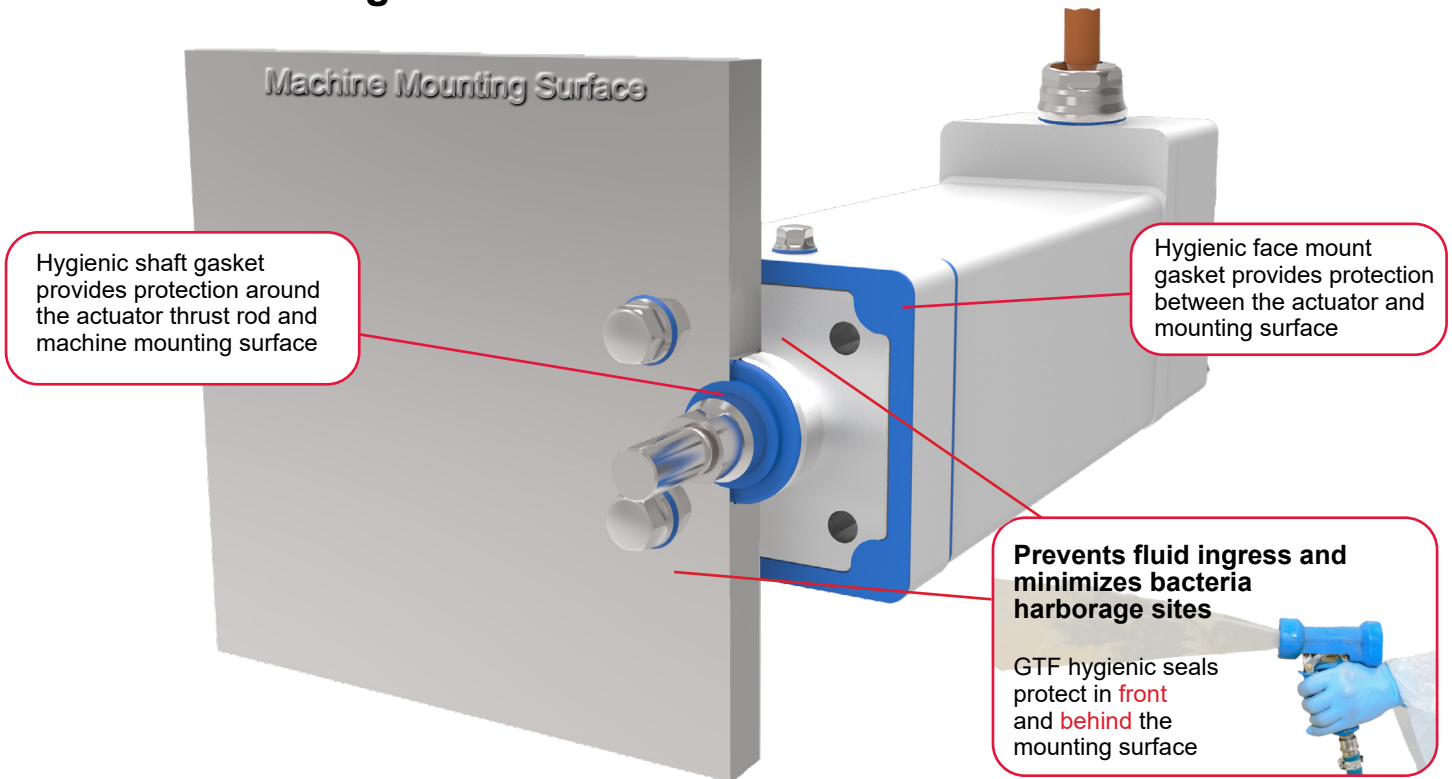

Clevis Mount Configuration

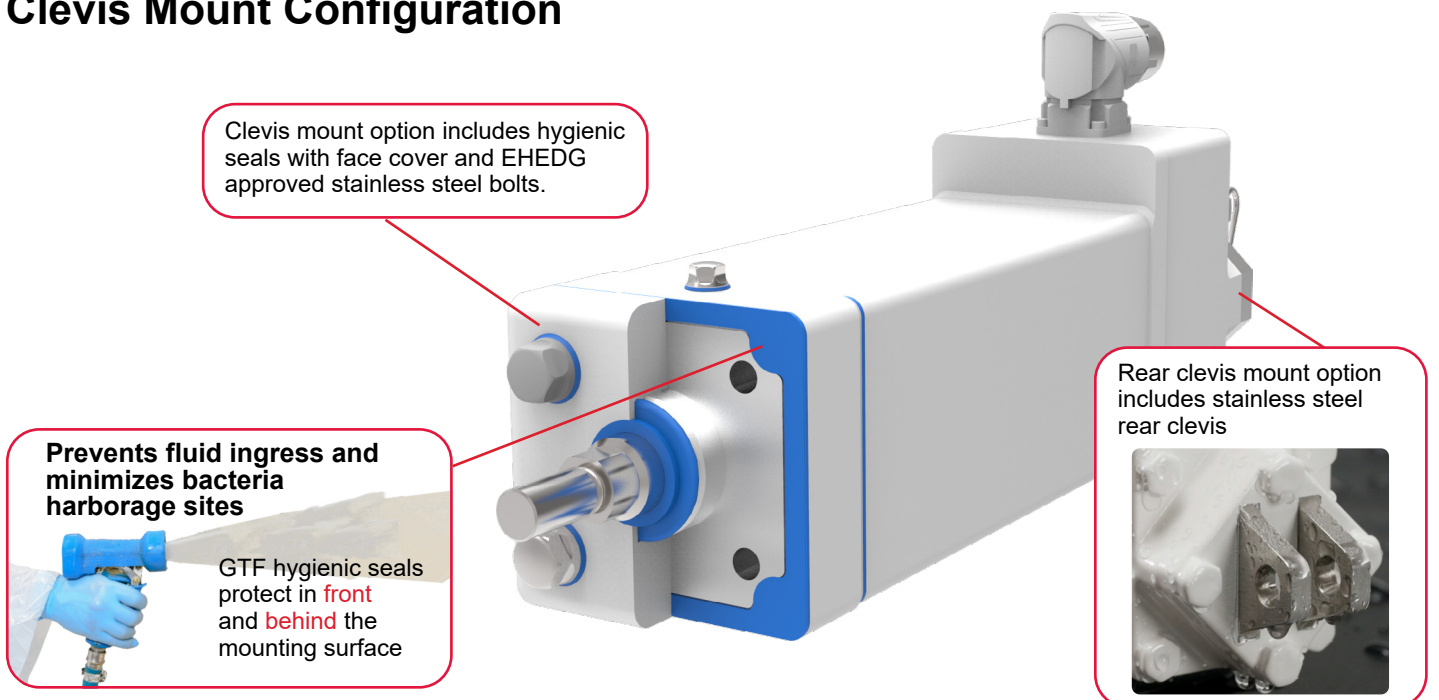

GTF Configuration Options

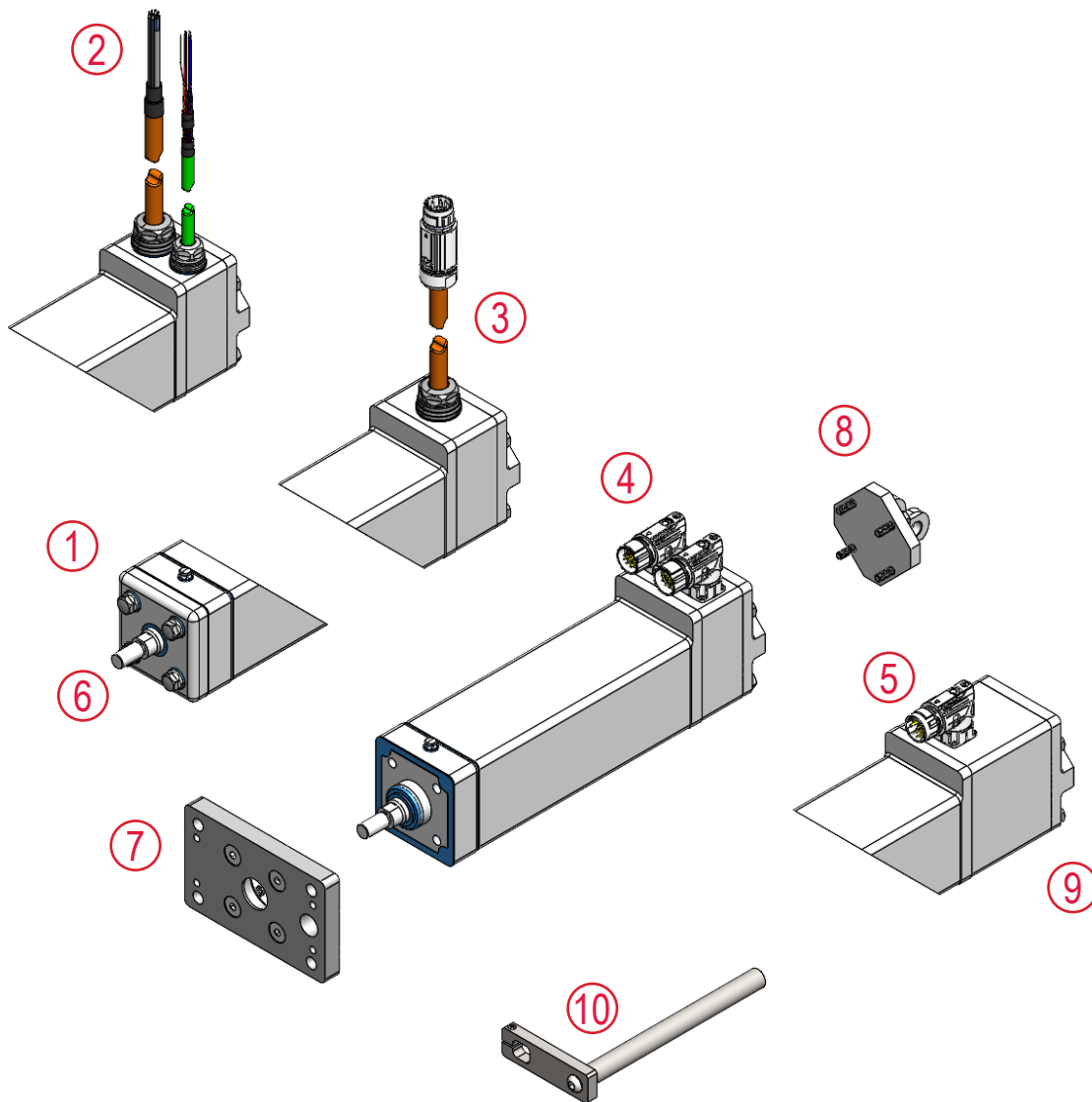

- 1 – Hygienic face cover with EHEDG Bolts (only with rear clevis mounting options)
- 2 – IP69K Extension cable with flying leads
- 3 – IP69K Extension cable with M23 connector
- 4 – IP67 Rotatable M23 connectors for motor power and feedback
- 5 – IP67 Rotatable M23 connector for single cable systems
- 6 – Metric/Imperial Male/Female rod end threads
- 7 – Metric/Imperial stainless steel front flange
- 8 – Stainless steel rear clevis (only with rear clevis mounting options)
- 9 – Rear power-off holding brake
- 10 – Stainless steel anti-rotate (only with front flange)

General Specifications

Operating Conditions and Usage		
Accuracy:		
Screw Lead Error	μm / 300 mm	25
	in/ft	0.001
Screw Travel Variation	μm / 300 mm	30
	in/ft	0.0012
Screw Backlash	imm	0.1524
	in	0.006
Ambient Operating Temperature	°C	0 to 25
	°F	0 to 77
Elevated Ambient Operating Temperature	°C	26 - 65 ¹
	°F	78 - 149 ¹
Friction Torque (typical)	Frame Size (Nm)	060 (0.12) 080 (0.23) 100 (0.34)
Environmental Rating with Standard M23 Connectors		IP67
Environmental Rating with Optional Extension Cables		IP69K ²

¹ Derating required for any ambient temperature in the Elevated Ambient Operating Temperature Range. See Page 15 for derating calculation.

² When actuator main shaft is stationary.

Agency Standards & Approvals		
UL		UL 1004-1
		UL 1004-6
CSA		CSA C22.2 NO. 100
CE	EMC	EN 55014-1
		EN 55014-2
	Safety	IEC/EN 60034-1
	RoHS	RoHS 2011/65/EU and amended with directive 2015/863

Material Specifications

Materials and Finish	
Rotatable Power and Feedback Connectors (IP67)	FDA approved cured food grade white paint over nickel plated zinc die cast housing
Cord Grip (IP69K)	EN 1.4404 (316L) Stainless steel with WMQ silicone seal
Extension Cable	PVC Jacket
Extension Cable Connectors	Nickle plated zinc die cast housing
Inner Shaft Seals	Parker Resilon® Polyurethane
Hygienic Front Seal	FDA approved Buna-N 70
Hygienic Face Mount Gasket	FDA approved Buna-N 70
Grease	FDA approved JAX Poly-Guard™ FG2 or Equivalent
Actuator Main Shaft	17-4 (H900) Stainless steel
Rear Clevis	303 Stainless steel, 63 microinch Finish
Rear Clevis Fasteners	18-8 Stainless steel
Face Cover Plate Fasteners	EHEDG EN1.4404 Stainless with 0.8 μm finish and NBR rubber seal
Purge Port Fasteners	EHEDG EN1.4404 Stainless with 0.8 μm finish and NBR rubber seal
Optional Mounting Flange	304 Stainless steel with 2 μm Finish and 18-8 stainless steel fasteners
Optional Anti-Rotate Arm for Mounting Flange	304 Stainless steel with 2 μm Finish
Bushing for Optional Anti-Rotate Arm	Igus iglide® A350 FDA Approved Plastic
Actuator Housing	FDA approved cured white epoxy over Type II anodized 6061-T6 aluminum
Actuator Housing Fasteners	FDA approved cured white epoxy over 18-8 stainless steel
Face Cover Plate	FDA approved powder coat epoxy over 6061-T6 aluminum
Product Label	Brady B-486B or equivalent metalized polyester with permanent rubber-based adhesive



Mechanical Specifications

GTF060

	Stroke Length mm (in)	Screw Lead mm (in)	Continuous Force Rating N (lbf)	Max Velocity mm/s (in/s)	Dynamic Load Rating N (lbf)	Armature Inertia kg-m ² (in-lb-s ²)
GTF060-080-01	80 (3.2)	2.54 (0.1)	2,668 (600)	318 (12.5)	9,230 (2,075)	0.00007367 (0.000652)
GTF060-080-02		5.08 (0.2)	1,900 (427)	635 (25.0)	6,850 (1,540)	
GTF060-080-04		10.2 (0.4)	1,006 (226)	1,270 (50.0)	5,471 (1,230)	
GTF060-150-01	150 (5.9)	2.54 (0.1)	2,668 (600)	318 (12.5)	9,230 (2,075)	0.00008689 (0.000769)
GTF060-150-02		5.08 (0.2)	1,900 (427)	635 (25.0)	6,850 (1,540)	
GTF060-150-04		10.2 (0.4)	1,006 (226)	1,270 (50.0)	5,471 (1,230)	
GTF060-300-01	300 (11.8)	2.54 (0.1)	2,668 (600)	318 (12.5)	9,230 (2,075)	0.00011537 (0.001021)
GTF060-300-02		5.08 (0.2)	1,900 (427)	635 (25.0)	6,850 (1,540)	
GTF060-300-04		10.2 (0.4)	1,006 (226)	1,270 (50.0)	5,471 (1,230)	

Maximum velocities listed at maximum voltages

Do not exceed 2X the continuous force rating during operation

Non-standard stroke lengths from 80 mm to 300 mm are available in 25 mm increments. Extended lead-times apply.

Continuous force rating based upon 25 °C ambient conditions

GTF080

	Stroke Length mm (in)	Screw Lead mm (in)	Continuous Force Rating N (lbf)	Max Velocity mm/s (in/s)	Dynamic Load Rating N (lbf)	Armature Inertia kg-m ² (in-lb-s ²)
GTF080-100-01	100 (3.9)	2.54 (0.1)	8,365 (1,881)	254 (10.0)	24,535 (5,516)	0.000340 (0.003013)
GTF080-100-02		5.08 (0.2)	4,740 (1,066)	508 (20.0)	25,798 (5,800)	
GTF080-100-05		12.7 (0.5)	2,008 (451)	1,270 (50.0)	21,795 (4,900)	
GTF080-150-01	150 (5.9)	2.54 (0.1)	8,365 (1,881)	254 (10.0)	24,535 (5,516)	0.000369 (0.003267)
GTF080-150-02		5.08 (0.2)	4,740 (1,066)	508 (20.0)	25,798 (5,800)	
GTF080-150-05		12.7 (0.5)	2,008 (451)	1,270 (50.0)	21,795 (4,900)	
GTF080-300-01	300 (11.8)	2.54 (0.1)	8,365 (1,881)	254 (10.0)	24,535 (5,516)	0.000455 (0.004029)
GTF080-300-02		5.08 (0.2)	4,740 (1,066)	508 (20.0)	25,798 (5,800)	
GTF080-300-05		12.7 (0.5)	2,008 (451)	1,270 (50.0)	21,795 (4,900)	
GTF080-450-01	450 (17.7)	2.54 (0.1)	8,365 (1,881)	254 (10.0)	24,535 (5,516)	0.000541 (0.004790)
GTF080-450-02		5.08 (0.2)	4,740 (1,066)	508 (20.0)	25,798 (5,800)	
GTF080-450-05		12.7 (0.5)	2,008 (451)	1,270 (50.0)	21,795 (4,900)	

Maximum velocities listed at maximum voltages

Do not exceed 2X the continuous force rating during operation

Non-standard stroke lengths from 100 mm to 450 mm are available in 25 mm increments. Extended lead-times apply.

Continuous force rating based upon 25 °C ambient conditions

GTF100

	Stroke Length mm (in)	Screw Lead mm (in)	Continuous Force Rating N (lbf)	Max Velocity mm/s (in/s)	Dynamic Load Rating N (lbf)	Armature Inertia kg-m ² (in-lb-s ²)
GTF100-150-01	150 (5.9)	2.54 (0.1)	15,392 (3,460)	191 (7.5)	54,557 (12,266)	0.0014085 (0.012467)
GTF100-150-02		5.08 (0.2)	12,098 (2,720)	381 (15.0)	55,972 (12,584)	
GTF100-150-05		12.7 (0.5)	5,444 (1,224)	953 (37.5)	37,141 (8,350)	
GTF100-300-01	300 (11.8)	2.54 (0.1)	15,392 (3,460)	191 (7.5)	54,557 (12,266)	0.0017399 (0.015399)
GTF100-300-02		5.08 (0.2)	12,098 (2,720)	381 (15.0)	55,972 (12,584)	
GTF100-300-05		12.7 (0.5)	5,444 (1,224)	953 (37.5)	37,141 (8,350)	

Maximum velocities listed at maximum voltages
Do not exceed 2X the continuous force rating during operation
Non-standard stroke lengths from 100 mm to 450 mm are available in 25 mm increments. Extended lead-times apply.
Continuous force rating based upon 25 °C ambient conditions

Estimated Service Life

GTF060

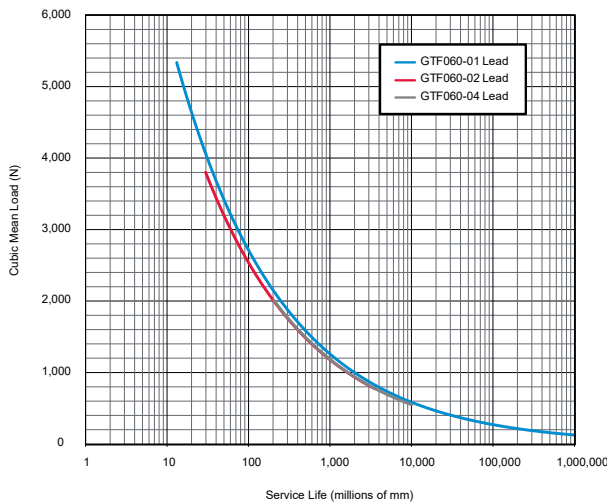

GTF080

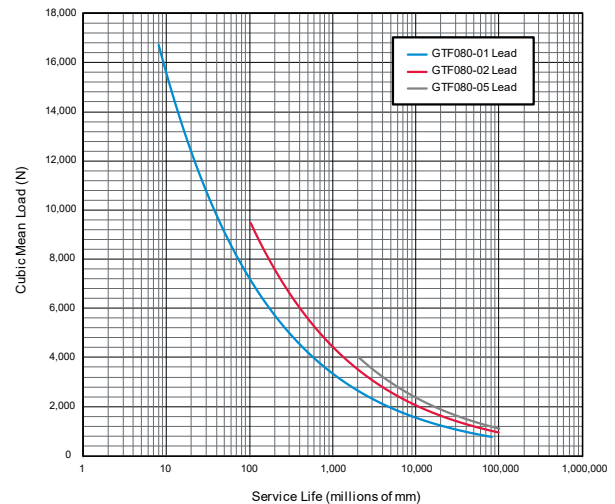

GTF100

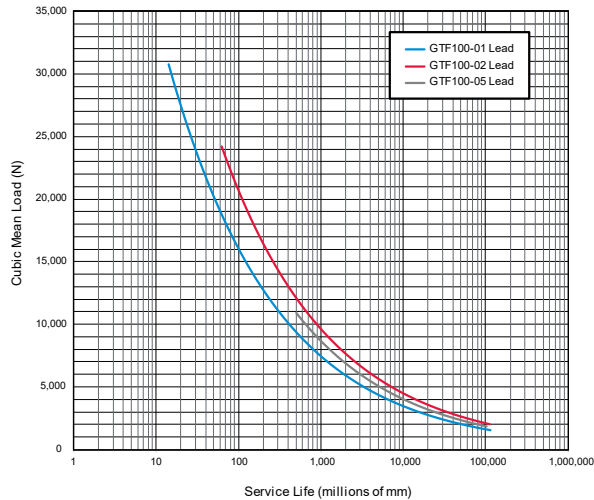

Service Life Estimate Assumptions:

- Sufficient quality and quantity of lubrication is maintained throughout service life
- No mechanical hard stops (external or internal) or impact loads
- No external side loads
- Does not apply to short stroke, high frequency applications such as fatigue testing or short stroke, high force applications such as pressing. If your application requires high force over a stroke length shorter than the length of the rollers/nut, please contact Exlar for additional details on calculating estimated service life. You may also download the article "Calculating Life Expectancy" at www.cw-actuation.com



The L_{10} expected life of a roller screw linear actuator is expressed as the linear travel distance that 90% of properly maintained roller screws manufactured are expected to meet or exceed. This is not a guarantee and these charts should be used for estimation purposes only. For additional details on calculating estimated service life, please refer www.cw-actuation.com.

The underlying formula that defines this value is below. Travel life in millions of millimeters, where:

$$L_{10} = \left(\frac{C_a}{F_{cmf}} \right)^3 \times \ell$$

C_a = Dynamic load rating (lbf)
 F_{cmf} = Cubic mean applied load (lbf)
 ℓ = Roller screw lead (inches)

Electrical Specifications

GTF060

Motor Voltage		4 (AC)		
Max Bus Voltage		230/460 Vac		
Speed @ Bus Voltage	rpm	5000/7500		
Actuator Lead	in	0.1	0.2	0.4
RMS Sinusoidal Commutation				
Continuous Motor Torque	Nm	1.35	1.81	1.81
	lbf-in	11.9	16.0	16.0
Continuous Current Rating	A	3.0	4.0	4.0
Peak Current Rating	A	6.0	8.0	8.0
Torque Constant (Kt) (±10% @ 25 °C)	Nm/A	0.5		
	lbf-in/A	4.5		
Voltage Constant (Ke) (± 10% @ 25 °C)	V/krpm	30.5		
0 - Peak Sinusoidal Commutation				
Continuous Motor Torque	Nm	1.81		
	lbf-in	16		
Continuous Current Rating	A	5.7		
Peak Current Rating	A	11.3		
Torque Constant (Kt) (± 10% @ 25 °C)	Nm/A	0.35		
	lbf-in/A	3.2		
Voltage Constant (Ke) (± 1% @ 25 °C)	V/krpm	43.1		
Pole Configuration	Number of Poles	8		
Resistance (L-L) (± 5% @ 25 °C)	Ohms	2.8		
Inductance (L-L)(± 15%)	mH	13.8		
Electrical Time Constant	ms	4.9		
Insulation Class	460 Vac Max, 180 °C (Class H)			

Specifications subject to change without notice
 Test data derived using NEMA recommended aluminum heatsink 10" x 10" x 1/4" at 25 °C ambient
 Vac Class winding operational compatible with drive voltages up to 460 Vac
 Rotational speed approximately proportional to drive input voltage

GTF060 Weights

Description	kg (lb)
GTF060-80	3.2 (7.0)
GTF060-100	3.3 (7.3)
GTF060-150	3.7 (8.1)
GTF060-300	4.8 (10.5)
Brake Adder	0.7 (1.4)
Stainless-steel Rear Clevis - Metric (7)	0.2 (0.5)
Stainless-steel Rear Clevis - Imperial (H)	0.3 (0.7)
Stainless-steel Front Flange - Metric (4)	0.63 (1.38)
Stainless-steel Front Flange - Imperial (G)	0.65 (1.43)
Stainless-steel Anti-Rotate Assembly (A) - 80	0.23 (0.52)
Stainless-steel Anti-Rotate Assembly (A) - 100	0.26 (0.57)
Stainless-steel Anti-Rotate Assembly (A) - 150	0.31 (0.67)
Stainless-steel Anti-Rotate Assembly (A) - 300	0.46 (1.01)

Brake Specifications

Brake Holding Torque (minimum)	Nm	2.5
	lbf-in	22
Brake Voltage	Vdc	24 (-10%/+6%)
Nominal Brake Current at 24 Vdc	A	0.46
Brake Engage/Disengage Time (typical)	ms	10/25

GTF080

Motor Voltage		4 (AC)
Max Bus Voltage		230/460 Vac
Speed @ Bus Voltage	rpm	3000/6000
RMS Sinusoidal Commutation		
Continuous Motor Torque	Nm	4.51
	lbf-in	39.9
Continuous Current Rating	A	4.9
Peak Current Rating	A	9.9
Torque Constant (Kt) (± 10% @ 25 °C)	Nm/A	1.02
	lbf-in/A	9.0
Voltage Constant (Ke) (± 10% @ 25 °C)	V/krpm	61.6
0 - Peak Sinusoidal Commutation		
Continuous Motor Torque	Nm	4.51
	lbf-in	39.9
Continuous Current Rating	A	6.6
Peak Current Rating	A	13.3
Torque Constant (Kt) (± 10% @ 25 °C)	Nm/A	0.72
	lbf-in/A	6.4
Voltage Constant (Ke) (± 10% @ 25 °C)	V/krpm	87.1
Pole Configuration	Number of Poles	8
Resistance (L-L) (± 5% @ 25 °C)	Ohms	2.5
Inductance (L-L)(±15%)	mH	17.3
Electrical Time Constant	ms	6.8
Insulation Class	460 Vac Max, 180 °C (Class H)	

Specifications subject to change without notice
 Test data derived using NEMA recommended aluminum heatsink 10" x 10" x 1/4" at 25 °C ambient
 Vac Class winding operational compatible with drive voltages up to 460 Vac
 Rotational speed approximately proportional to drive input voltage

GTF080 Weights	
Description	kg (lb)
GTF080-100	6.1 (13.5)
GTF080-150	6.8 (14.9)
GTF080-300	8.6 (19.0)
GTF080-450	10.5 (23.1)
Brake Adder	1.1 (2.5)
Stainless-steel Rear Clevis - Metric (7)	0.4 (0.8)
Stainless-steel Rear Clevis - Imperial (H)	0.8 (1.7)
Stainless-steel Front Flange - Metric (4)	1.33 (2.93)
Stainless-steel Front Flange - Imperial (G)	1.39 (3.07)
Stainless-steel Anti-Rotate Assembly (A) - 80	0.43 (0.95)
Stainless-steel Anti-Rotate Assembly (A) - 150	0.51 (1.13)
Stainless-steel Anti-Rotate Assembly (A) - 300	0.75 (1.65)
Stainless-steel Anti-Rotate Assembly (A) - 450	0.99 (2.18)

Brake Specifications		
Brake Holding Torque (minimum)	Nm	4.5
	lbf-in	40
Brake Voltage	Vdc	24 (-10%/+6%)
Nominal Brake Current at 24 Vdc	A	0.5
Brake Engage/Disengage Time (typical)	ms	18/35

GTF100

Motor Voltage		4 (AC)
Max Bus Voltage		230/460 Vac
Speed @ Bus Voltage	rpm	3000/4500
RMS Sinusoidal Commutation		
Continuous Motor Torque*	Nm	12.23
	lbf-in	108.2
Continuous Current Rating*	A	12.3
Peak Current Rating*	A	24.7
Torque Constant (Kt) (± 10% @ 25 °C)	Nm/A	1.11
	lbf-in/A	9.8
Voltage Constant (Ke) (± 10% @ 25 °C)	V/krpm	67.0
0 - Peak Sinusoidal Commutation		
Continuous Motor Torque	Nm	12.23
	lbf-in	108.2
Continuous Current Rating	A	17.4
Peak Current Rating	A	34.8
Torque Constant (Kt) (± 10% @ 25 °C)	Nm/A	0.78
	lbf-in/A	6.92
Voltage Constant (Ke) (± 10% @ 25 °C)	V/krpm	94.8
Pole Configuration	Number of Poles	8
Resistance (L-L) (± 5% @ 25 °C)	Ohms	0.65
Inductance (L-L)(± 15%)	mH	4.9
Electrical Time Constant	ms	7.6
Insulation Class	460 Vac Max, 180 °C (Class H)	

Specifications subject to change without notice

Test data derived using NEMA recommended aluminum heatsink 12" x 12" x 1/2" at 25 °C ambient

Vac Class winding operational compatible with drive voltages up to 460 Vac

Rotational speed approximately proportional to drive input voltage

* For actuators with a 0.1" lead, the torque and current must be limited to 8.89 Nm/9.0 A not to exceed the continuous force rating specified in the mechanical specifications table on page 9. Peak torque and current values would be 2x the continuous values

GTF100 Weights

Description	kg (lb)
GTF100-150	13.1 (28.8)
GTF100-300	16.0 (35.2)
Brake Adder	1.2 (2.7)
Stainless-steel Rear Clevis - Metric (7)	0.8 (1.8)
Stainless-steel Rear Clevis - Imperial (H)	1.1 (2.5)
Stainless-steel Front Flange - Metric (4)	2.09 (4.60)
Stainless-steel Front Flange - Imperial (G)	1.94 (4.27)
Stainless-steel Anti-Rotate Assembly (A) - 150	1.36 (3.00)
Stainless-steel Anti-Rotate Assembly (A) - 300	1.97 (4.34)

Brake Specifications

Brake Holding Torque (minimum)	Nm	11
	lbf-in	97
Brake Voltage	Vdc	24 (-10%/+6%)
Nominal Brake Current at 24 Vdc	A	0.75
Brake Engage/Disengage Time (typical)	ms	25/40

Speed vs. Force Curves

These charts represent typical linear speed versus linear force curves for the GTF actuators using common brushless motor amplifiers. The GTF Series are compatible with many different brushless motor amplifiers; any differences in the performance ratings of these amplifiers can alter the actuator's performance. Thus, the curves below should be used for estimation only. (Further information is available by contacting your local sales representative.)

GTX060 - AC Voltage Winding

GTF060 - 01

2.54 mm (0.1 in) Screw Lead

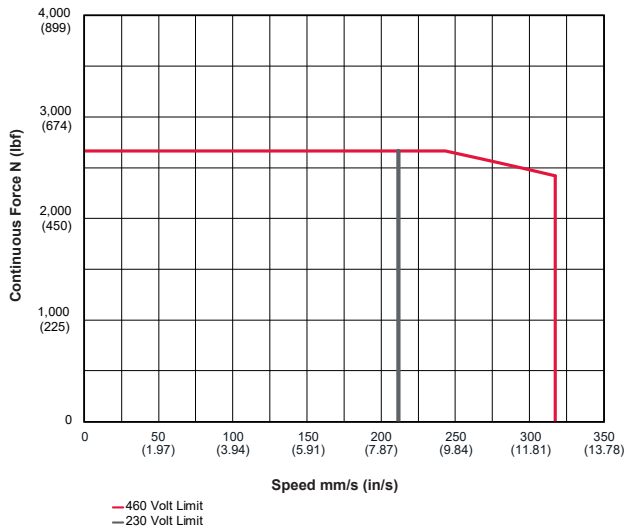

GTF060 0- 04

10.16 mm (0.4 in) Screw Lead

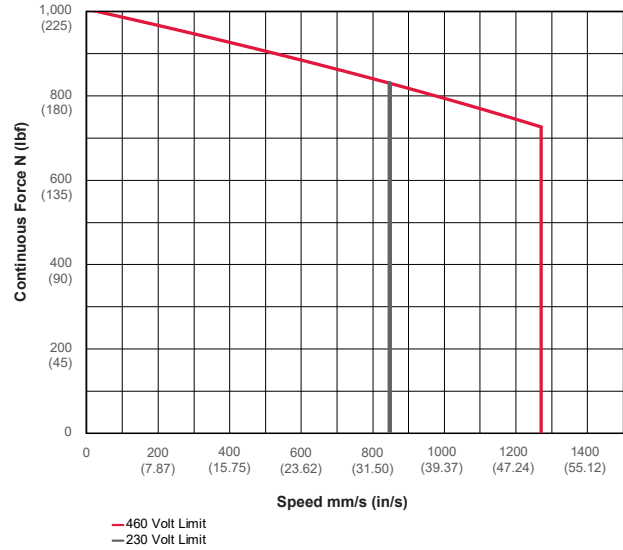

GTF060 - 02

5.08 mm (0.2 in) Screw Lead

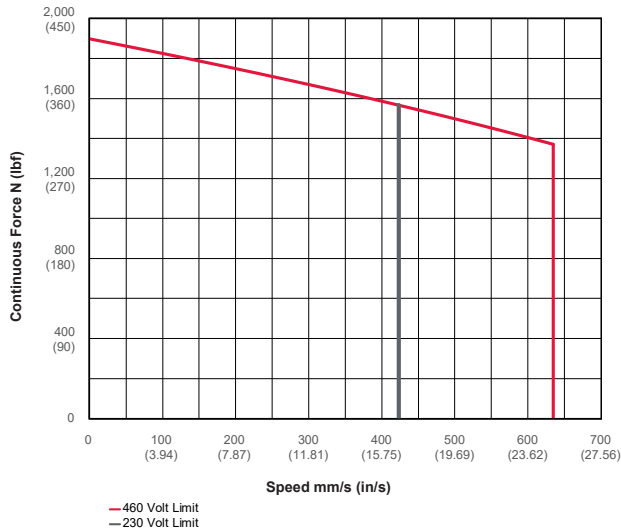

Test data derived using NEMA recommended aluminum heatsink 10" x 10" x 1/4" for GTX080.



GTF080 - AC Voltage Winding

GTF080 - 01
2.54 mm (0.1 in) Screw Lead

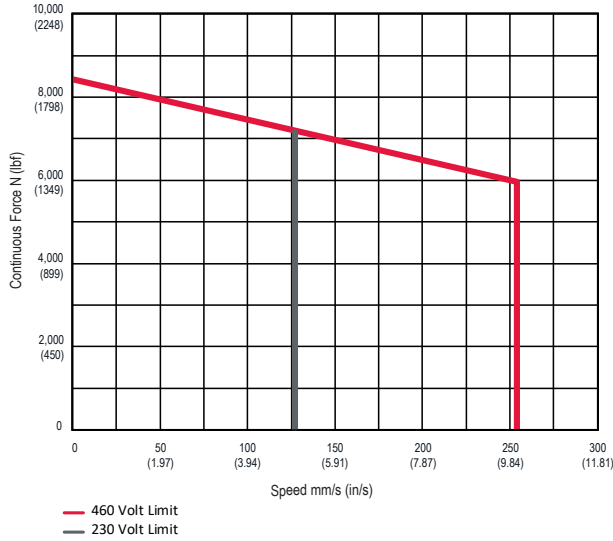

GTF080 - 05
12.7 mm (0.5 in) Screw Lead

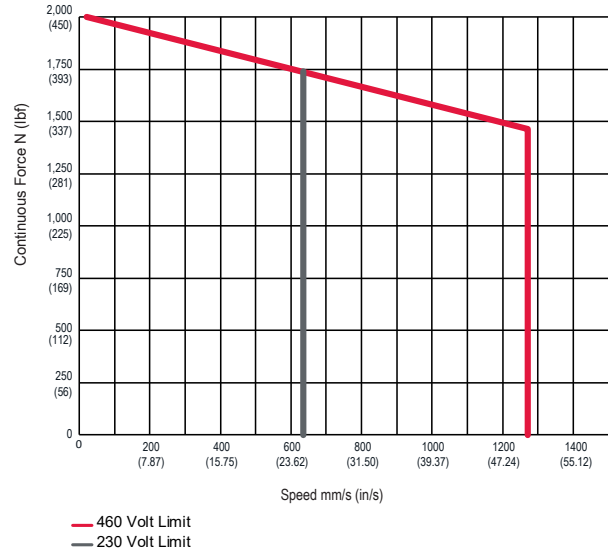

GTF080 - 02
5.08 mm (0.2 in) Screw Lead

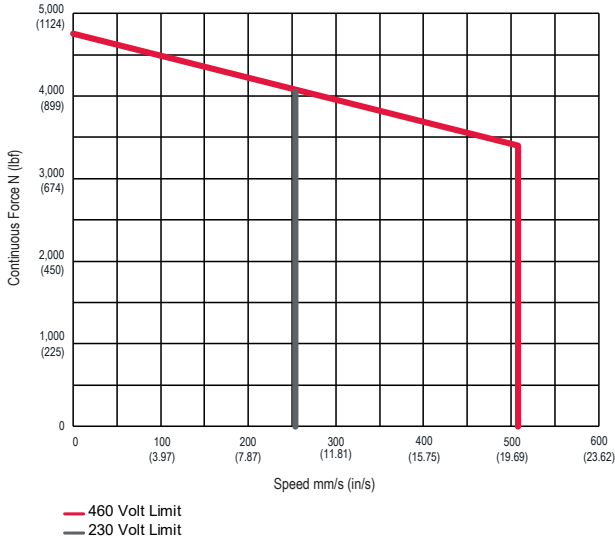

GTF100 - AC Voltage Winding

GTF100 - 01
2.54 mm (0.1 in) Screw Lead

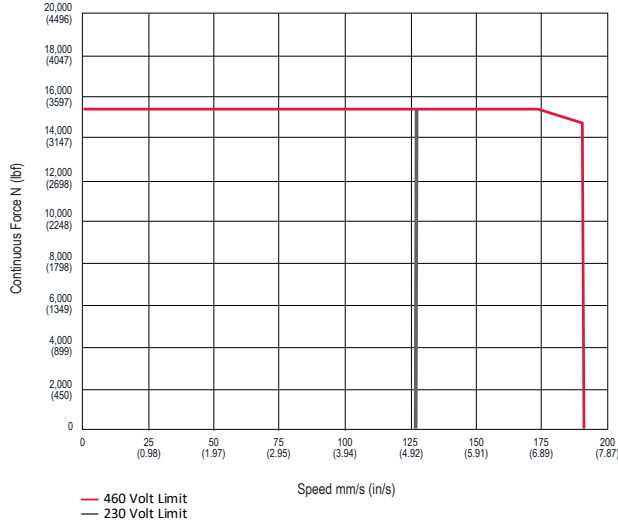

GTF100 - 05
12.7 mm (0.5 in) Screw Lead

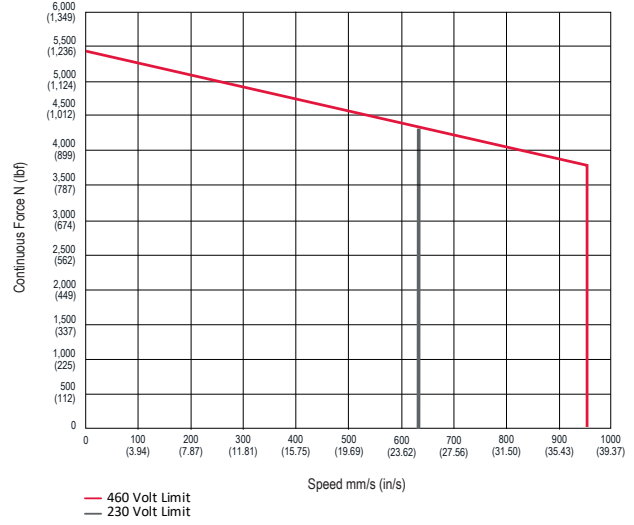

GTF100 - 02
5.08 mm (0.2 in) Screw Lead

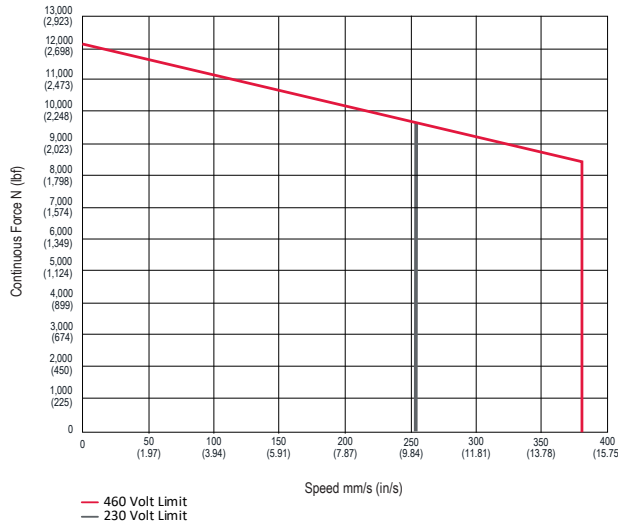

Elevated Ambient Temperature Operation

The speed/torque curves are based on 25° C ambient conditions. The actuators may be operated at ambient temperatures up to 65° C.

Elevated Ambient Temp Factor (%) =

$$100\% \times \sqrt{\frac{\text{Max Rated Temp } [\sim 130 \text{ } ^\circ\text{C}] - \text{Environment Temp } [\text{in } ^\circ\text{C}]}{\text{Max Rated Temp } [\sim 130 \text{ } ^\circ\text{C}] - \text{Rated Ambient } [\sim 25 \text{ } ^\circ\text{C}]}} =$$

Options

Motor Winding / Voltage

GTF actuators can be operated at a wide range of voltages (up to 460 Vac). Refer to the mechanical/electrical specifications for motor torque and actuator rated force.

4	460 Vac Max
---	-------------

Internal Holding Brake

This option provides an internal holding brake for GTF Series actuators. The brake is a permanent magnet brake that is normally engaged. Power must be applied to the brake to disengage the brake.

Feedback Device Options:

Resolvers

Incremental Encoders

Absolute Encoders

Exlar GTF actuators are compatible with a variety of drive platforms available today. Exlar installs, aligns, and wires feedback devices to mimic a typical motor's wiring and cabling commonly used with the listed amplifier manufacturer (see wiring and alignment section for details). If your wiring and alignment is not listed, please consult Exlar.

Mounting Options

To help you save time and cost on hygienic machines, the GTF linear actuator is designed for two different mounting methods: **face-mounting and rear-clevis mounting**.

The GTF face mount option provides a simple means for customers to completely seal the face of the actuator to a mounting plate on the machine system.

The GTF clevis mount option provides a hygienic face plate and stainless-steel rear clevis mount.

Dimensions

GTF060 BASE ACTUATOR

ALL DIMENSIONS ARE IN MILLIMETERS

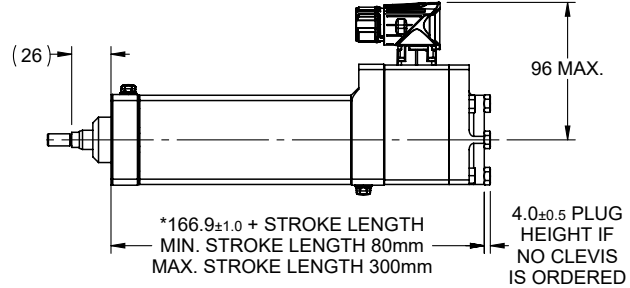
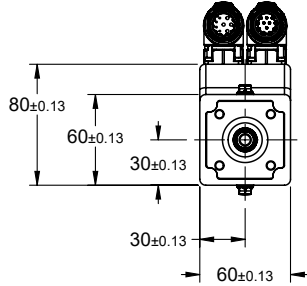

NOTE: * ADD 50mm TO THE OVERALL LENGTH IF ORDERING A BRAKE.

FACE MOUNT INTERFACE DIMENSIONS

ACTUATOR DIMENSIONS

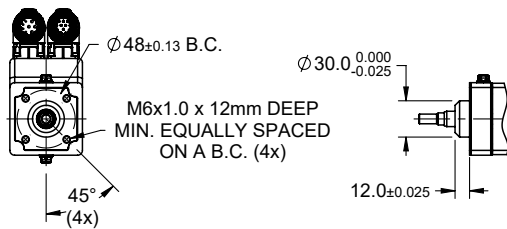

CUSTOMER MOUNTING SURFACE DIMENSIONS

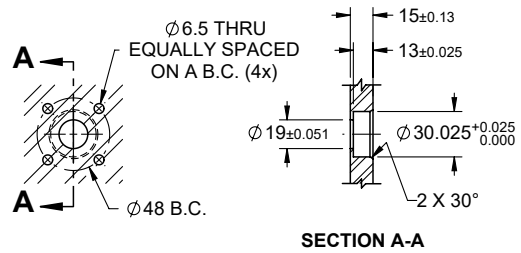

4 (FRONT FLANGE MOUNT CONFIGURATION)

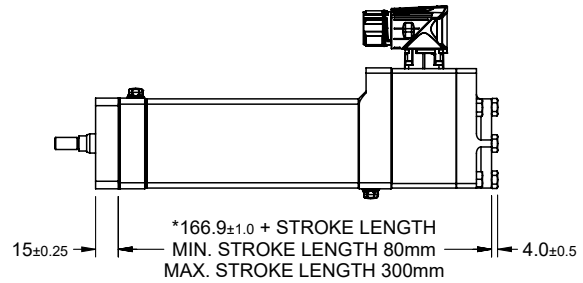
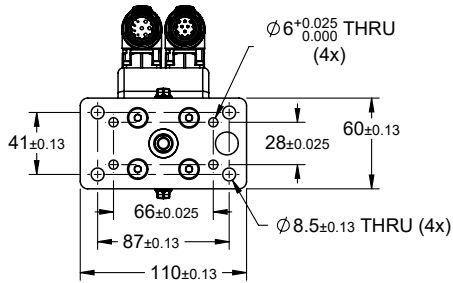

NOTE: * ADD 50mm TO THE OVERALL LENGTH IF ORDERING A BRAKE.

7 (CLEVIS MOUNT CONFIGURATION)

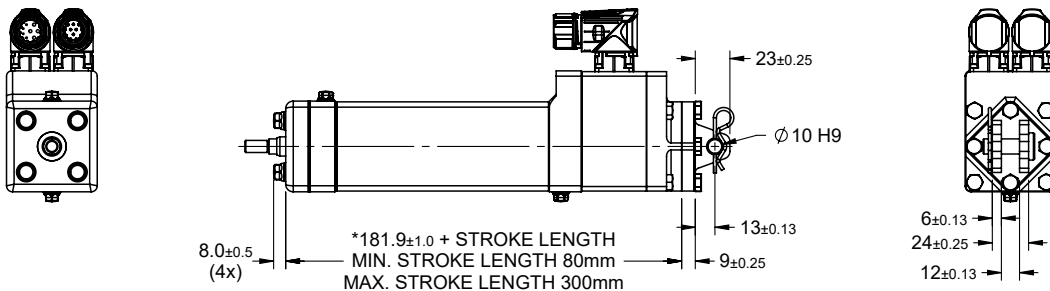

NOTE: * ADD 50mm TO THE OVERALL LENGTH IF ORDERING A BRAKE.

NOTE: ø10 h9 CLEVIS PIN (18-8 STAINLESS STEEL) IS INCLUDED.

Pre-sale drawings and models are representative and are subject to change. Visit exlar.com to download a 3D model of your desired configuration.

A (ANTI-ROTATE OPTION)

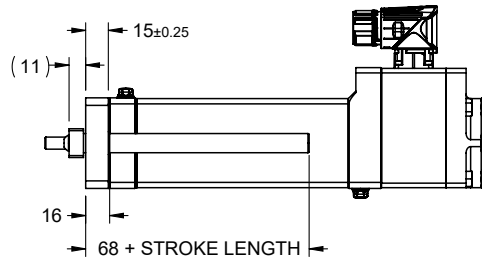
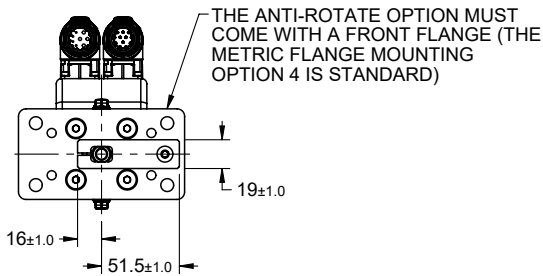

CABLE OPTIONS

STANDARD CABLE LENGTHS
3 METERS -0mm/+150mm
6 METERS -0mm/+300mm
9 METERS -0mm/+450mm

DUAL CABLES WITH FLYING LEADS

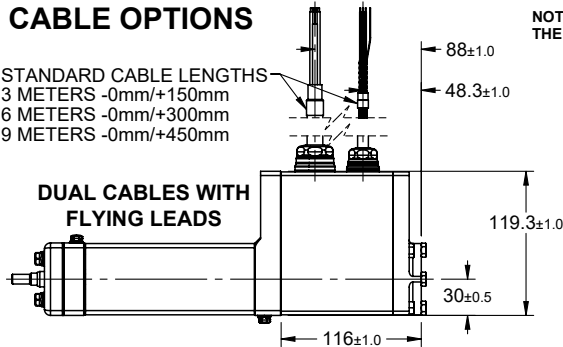

NOTE: UNITS WITH AND WITHOUT A BRAKE USE THE SAME HOUSING.

STANDARD CABLE LENGTHS
3 METERS -0mm/+150mm
6 METERS -0mm/+300mm
9 METERS -0mm/+450mm

HIPERFACE DSL SINGLE CABLE WITH CONNECTOR

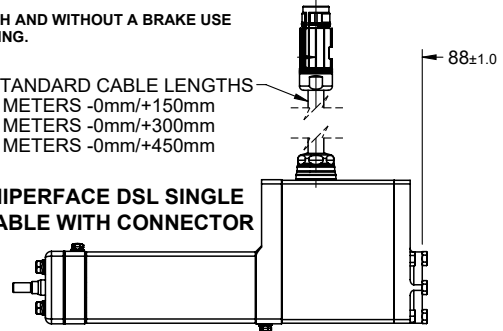

ROD ENDS

L - FEMALE METRIC
(V - FEMALE IMPERIAL)

R - MALE METRIC
(W - MALE IMPERIAL)

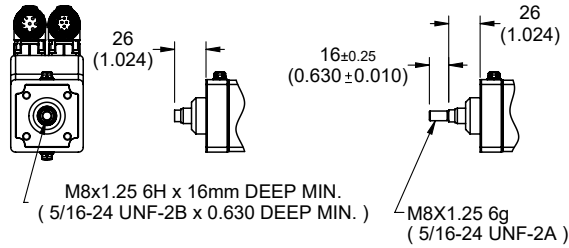

BRAKE ADDER LOCATION

50mm (1.969 in) ADDER

NON-BRAKE HOUSING

BRAKE HOUSING

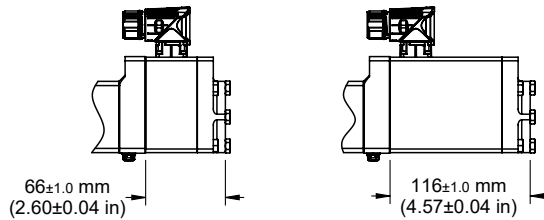

GTF060 IMPERIAL OPTIONS

ALL DIMENSIONS ARE IN INCHES

G (GSX20 FRONT FLANGE)

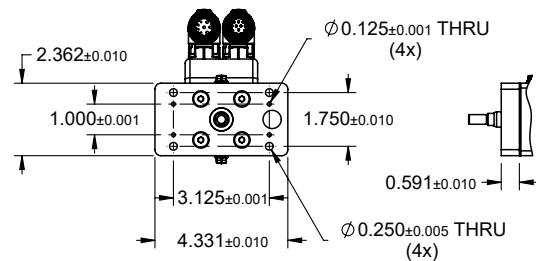

H (GSX20 REAR CLEVIS)

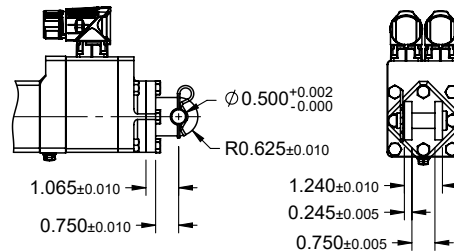

NOTE: ø0.499/ø0.498 CLEVIS PIN (17-4 STAINLESS STEEL) IS INCLUDED.

GTF080 BASE ACTUATOR

ALL DIMENSIONS ARE IN MILLIMETERS

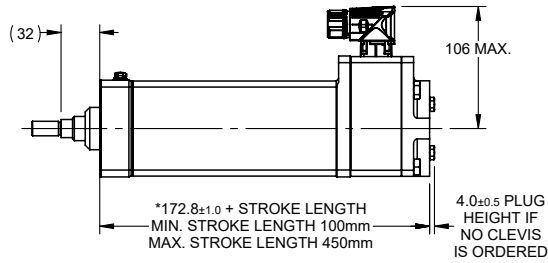
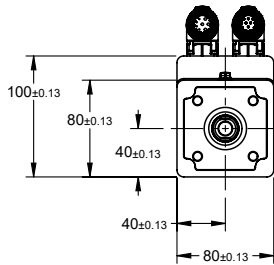

NOTE: * ADD 40mm TO THE OVERALL LENGTH IF ORDERING A BRAKE.

FACE MOUNT INTERFACE DIMENSIONS

ACTUATOR DIMENSIONS

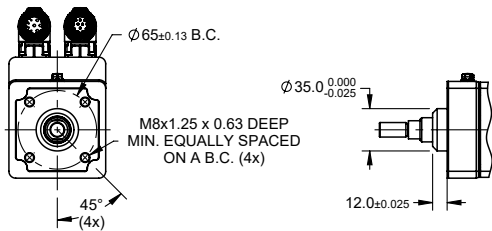

CUSTOMER MOUNTING DIMENSIONS

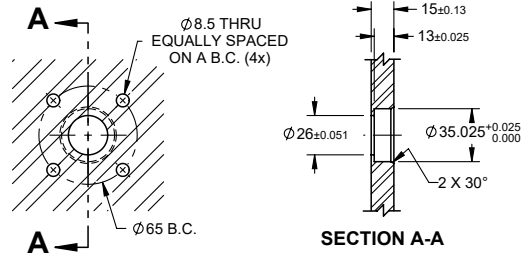

4 (FRONT FLANGE MOUNT CONFIGURATION)

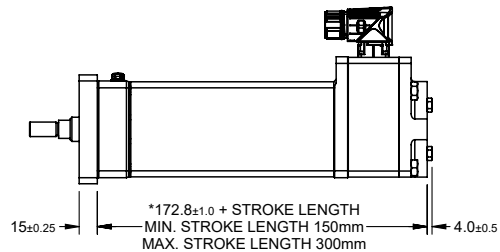
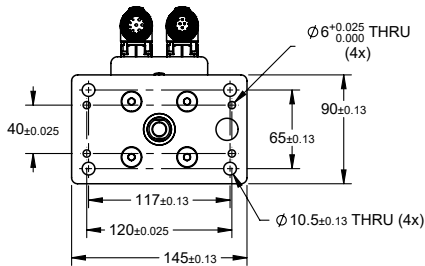

NOTE: * ADD 40mm TO THE OVERALL LENGTH IF ORDERING A BRAKE.

7 (CLEVIS MOUNT CONFIGURATION)

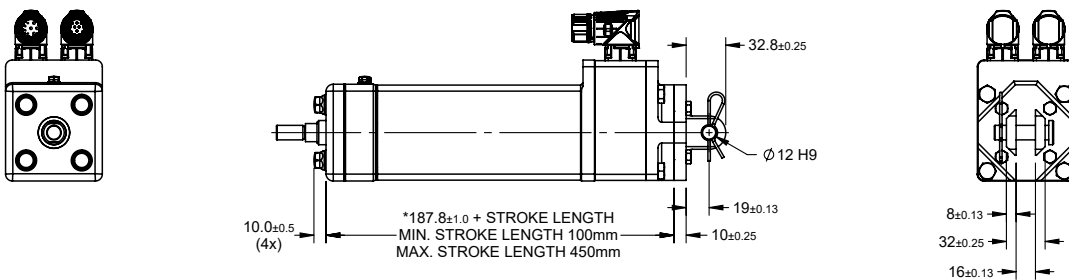

NOTE: * ADD 40mm TO THE OVERALL LENGTH IF ORDERING A BRAKE.

NOTE: Ø12 h9 CLEVIS PIN (18-8 Stainless Steel) IS INCLUDED.

A (ANTI-ROTATE OPTION)

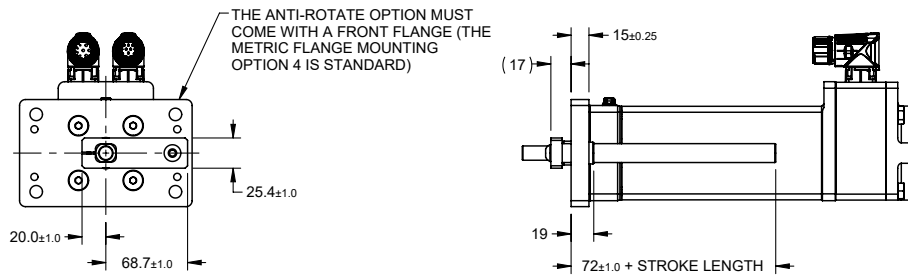

CABLE OPTIONS

DUAL CABLE WITH FLYING LEADS

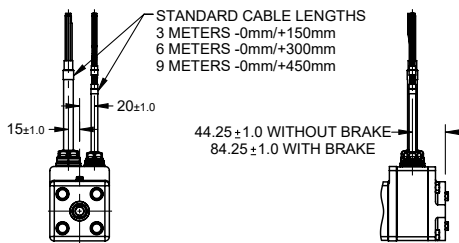

HIPERFACE DSL SINGLE CABLE WITH CONNECTOR

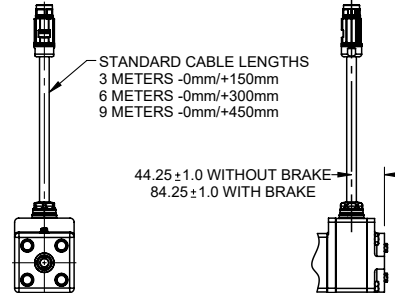

ROD ENDS

L - FEMALE METRIC (V - MALE IMPERIAL)

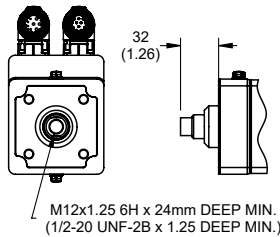

R - MALE METRIC (W - MALE IMPERIAL)

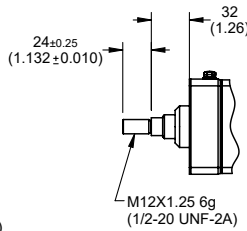

BRAKE ADDER LOCATION

40mm (1.575 in) ADDER

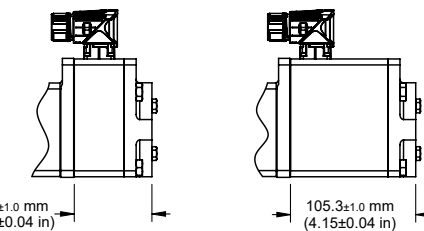

GTF080 IMPERIAL OPTIONS

ALL DIMENSIONS ARE IN INCHES

G (GSX30 FRONT FLANGE)

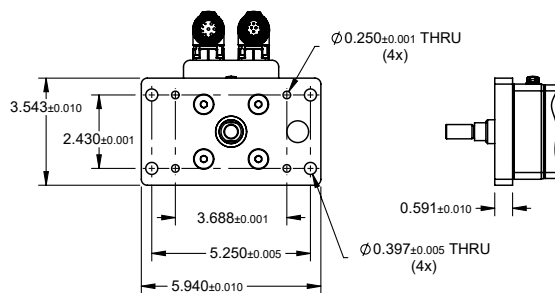

H (GSX30 REAR CLEVIS)

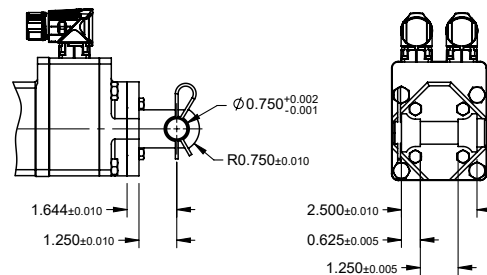

NOTE: Ø0.748/Ø0.746 CLEVIS PIN (18-8 STAINLESS STEEL) IS INCLUDED.

GTF100 BASE ACTUATOR
ALL DIMENSIONS ARE IN MILLIMETERS

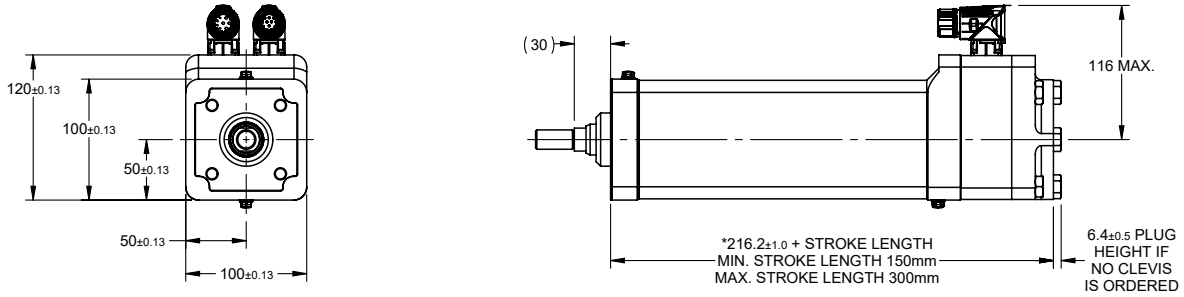

NOTE: * ADD 40mm TO THE OVERALL LENGTH IF ORDERING A BRAKE.

FACE MOUNT INTERFACE DIMENSIONS

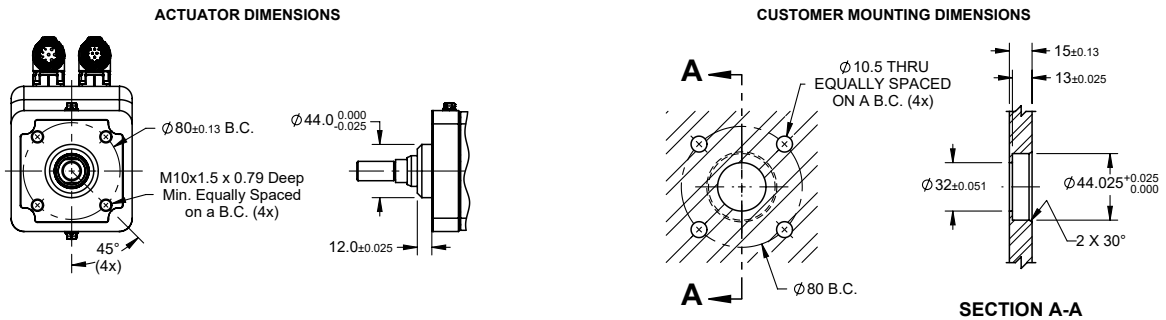

4 (FRONT FLANGE MOUNT CONFIGURATION)

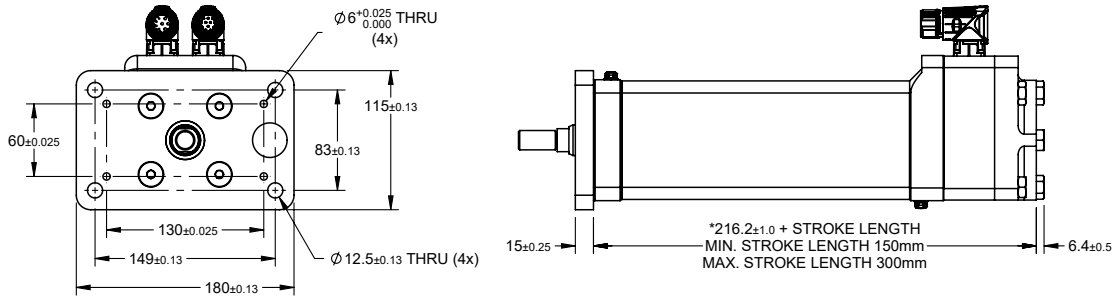

NOTE: * ADD 40mm TO THE OVERALL LENGTH IF ORDERING A BRAKE.

7 (CLEVIS MOUNT CONFIGURATION)

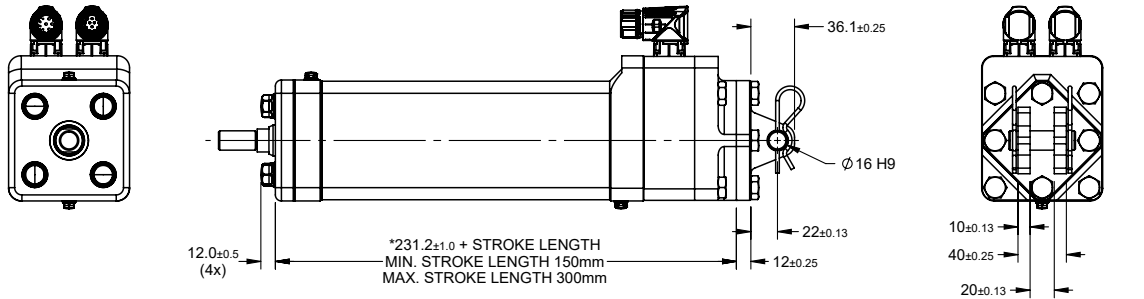

NOTE: * ADD 40mm TO THE OVERALL LENGTH IF ORDERING A BRAKE.

NOTE: $\phi 16 \text{ h9}$ CLEVIS PIN (17-4 STAINLESS STEEL) IS INCLUDED.

A (ANTI-ROTATE)

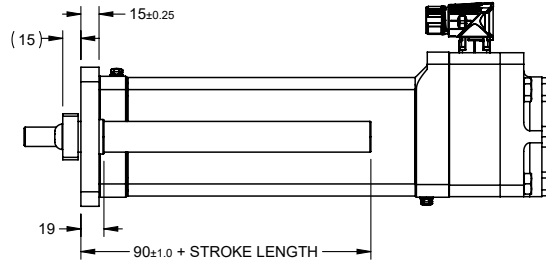
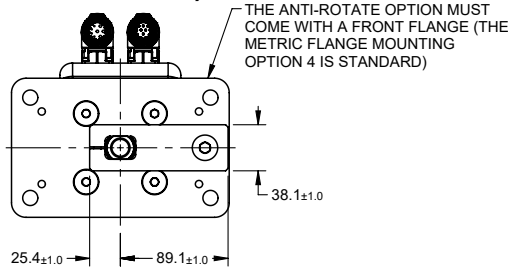

CABLE OPTIONS

DUAL CABLE WITH FLYING LEADS

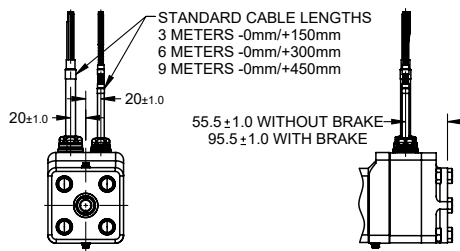

HIPERFACE DSL SINGLE CABLE WITH CONNECTOR

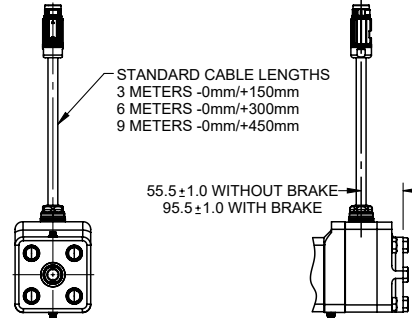

ROD ENDS

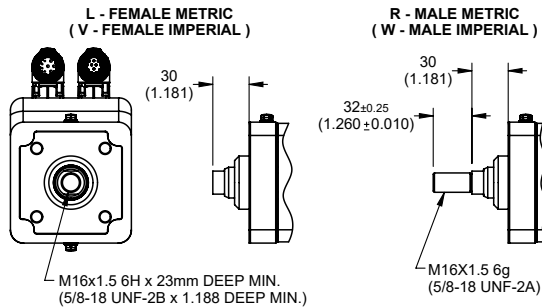

BRAKE ADDER LOCATION

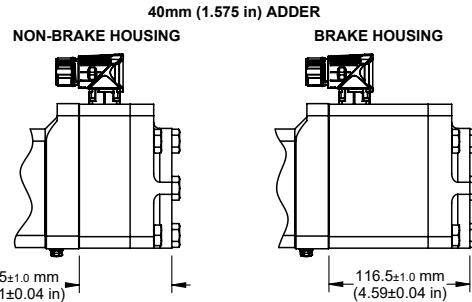

GTF100 IMPERIAL OPTIONS

ALL DIMENSIONS ARE IN INCHES

G (GSX40 FRONT FLANGE)

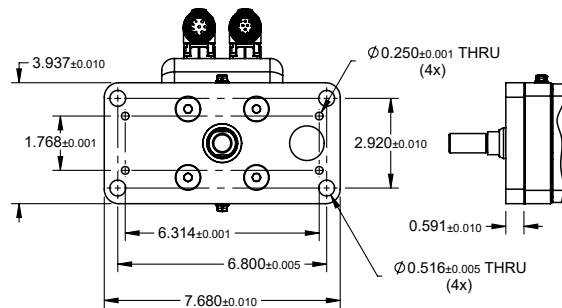

H (GSX40 REAR CLEVIS)

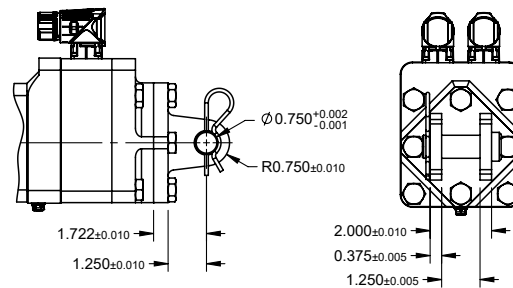

NOTE: Ø0.748/Ø0.746 CLEVIS PIN (18-8 STAINLESS STEEL) IS INCLUDED.



Feedback Types for GTF

Drive / Feedback Designator Callouts

Drive Manufacturers	Wiring & Alignment Code	Resolver	Incremental Encoder	SICK Hiperface Absolute Encoder	SICK Hiperface DSL Absolute Encoder	Heidenhain Endat 2.1 Absolute Encoder ¹	Heidenhain Endat 2.2 Absolute Encoder ²
AMK	AK	R1A1				H1A1	
B&R Automation	BR	R1A1				H1A2	H3A8 ³
Baldor	BD	R1A1				H1A1	
Baumuller	BM	R1A1		S1A1		H1A2	
Beckhoff Automation	BE				S4C0 ³	H1A2	H3C2 ³
Control Technologies / Nidec	CT	R2B1	E1B2	S1B1		H1B2	
Elau / Schneider	EU			S1A1 ⁴			
Elmo Motion Control	EL	R1B1	E1B2			H1B2	
Curtiss-Wright Exlar	EX	R1A1	E1A2	S1A2		H1A2	
Curtiss-Wright Exlar Flying Lead Cables	EX	R1Zx ⁵	E1Zx ⁵	S1Zx ⁵		H1Zx ⁵	
Infranor	IF	R1B2		S1B2			
Bosch-Rexroth	IN			S2D3 ⁴		H1D3	
Kollmorgen	KM	R2A1	E1A2			H1A2	
LTi	LS	R2A1		S1A2			
Lenze	LZ	R1B1		S1B1			
Parker	PC	R1B1	E1B2			H1B2	
Rockwell Automation	RA		E1C2	S1C2 ⁴	S3C0 ⁴		
Rockwell Automation Extension Cable with Connector	RA				S3Kx ^{4,5}		
Siemens	SM	R1B1				H1B2	
Stober Drives	SB	R4A1				H1A1	

¹Synchronous serial EnDat 2.1 with 1 Vpp Incremental Signals (EnDat01)

²Synchronous serial EnDat 2.2 without Incremental Signals (EnDat22)

³Supports Functional Safety

⁴Encoder is pre-programmed for operation with the manufacturer's servo drives.

⁵x=Refer to length options in feedback and connector tables below

Feedbacks	
R1 – Resolver, 2-pole, 5 kHz, 4 V, Transformation Ratio 0.5±10%	S2 – SICK Hiperface, SKM36 Multi-turn Absolute Encoder, 18-bit, Bosch-Rexroth
R2 – Resolver, 2-pole, 7 kHz, 4.25 V, Transformation Ratio 0.47±5%	S3 – SICK Hiperface DSL, EKM36 Multi-turn Absolute Encoder, 18-bit
R4 - Resolver, 2-pole, 10 kHz, 7 V, Transformation Ratio 0.5±5%	S4 – SICK Hiperface DSL, EKM36 Multi-turn Absolute Encoder, 18-bit, Functional Safety
E1 – Incremental Encoder, 2048 PPR (8192 counts), 8-pole, 5 V, Index Pulse, Hall commutation, 5 Vdc	H1 – Heidenhain EnDat 2.1, EQN 1125 Multi-turn Absolute Encoder, 13-bit
S1 – SICK Hiperface, SKM36 Multi-turn Absolute Encoder, 18-bit	H3 – Heidenhain EnDat 2.2, EQN 1135 Multi-turn Absolute Encoder, 23-bit, Functional Safety

Power Connectors	Feedback Connectors
A = 8 pin M23 Size 1, Right Angle Connector, TE BEDC110MR11001216000 or equiv.	0 = Feedback signal wired through power connector
B = 6 pin M23 Size 1, Right Angle Connector, TE BEDC106MR14001216000 or equiv.	1 = 12 pin M23 Size 1, P Type, Right Angle Connector, TE AEDC052MS06001215000 or equiv.
C = 9 pin M23 Size 1, Right Angle Connector, TE BEDC091MR30001216000 or equiv.	2 = 17 pin M23 Size 1, E Type, Right Angle Connector, TE AEDC113MS06001215000 or equiv.
D = 4+5 pin M23 size 1, Right Angle Connector, Bosch Rexroth R911309687	3 = 10 pin M23 Size 1, Right Angle Connector, Bosch Rexroth R911309733
K = Extension Cable with 9 pin M23 Size 1 Straight Connector ¹ , TE BKUA145MR30550200000 or equiv.	5 = 8 pin M12, Straight Connector
Z = Flying Lead Cables for Power and Feedback ¹	8 = 12 pin M23 Size 1, Series 615 ITEC, Right Angle Connector, TE EEDA001MR02000600000 or equiv.
	C = 3-meter cable length ¹
	D = 6-meter cable length ¹
	E = 9-meter cable length ¹

¹Only available for GTF product line



Wiring and Alignment Options

AMK-Resolver (AK-R1A1) - Standard Resolver w/M23 connectors

Power Connector Pin-Out		Pin Side View
Pin Number	Signal	
1	U	
2	PE	
3	W	
4	V	
A	TH	
B	TH	
C	BR +	
D	BR 0V	

Feedback Connector Pin-Out		Pin Side View
Pin Number	Signal	
1	+ Sin	
2	- Sin	
3	+ Cos	
4	- Cos	
5	-	
6	-	
7	-	
8	Shield	
9	+ UREF	
10	- UREF	
11	-	
12	-	
Actuator Case	-	

B & R Automation-Resolver (BR-R1A1) - Standard Resolver w/M23 connectors

Power Connector Pin-Out		Pin Side View
Pin Number	Signal	
1	U	
2	PE	
3	W	
4	V	
A	PT1000	
B	PT1000	
C	Brake+	
D	Brake-	

Feedback Connector Pin-Out		Pin Side View
Pin Number	Signal	
1	-	
2	-	
3	Cos+	
4	Sin+	
5	Ref+	
6	-	
7	Cos-	
8	Sin-	
9	Ref-	
10	-	
11	-	
12	-	
Actuator Case	-	

Mfg's Cable Part Number-
8CRXXX.12-1

AMK-Heidenhain (AK-H1A1) - EnDat 2.2 Heidenhain EQN1125 multi-turn absolute encoder - ED/EK motor wiring w/M23 connectors

Power Connector Pin-Out		Pin Side View
Pin Number	Signal	
1	U	
2	PE	
3	W	
4	V	
A	TH	
B	TH	
C	BR +	
D	BR 0V	

Feedback Connector Pin-Out		Pin Side View
Pin Number	Signal	
1	G2N	
2	G2I	
3	G1N	
4	G1I	
5	05P	
6	GND	
7	CLK+	
8	CLK-	
9	DAT+	
10	DAT-	
11	05P	
12	GND	
Actuator Case	-	

B & R Automation-Heidenhain (BR-H1A2) - EnDat 2.2 Heidenhain EQN1125 multi-turn absolute encoder - 8LS/8LM motor wiring w/M23 connectors

Power Connector Pin-Out		Pin Side View
Pin Number	Signal	
1	U	
2	PE	
3	W	
4	V	
A	PT1000	
B	PT1000	
C	Brake+	
D	Brake-	

Feedback Connector Pin-Out		Pin Side View
Pin Number	Signal	
1	Up Sense	
2	-	
3	-	
4	0V Sense	
5	-	
6	-	
7	Up voltage supply	
8	Clock	
9	Clock-	
10	0V voltage supply	
11	-	
12	B+	
13	B-	
14	Data	
15	A+	
16	A-	
17	Data-	
Actuator Case	-	

Mfg's Cable Part Number-
8CEXXX.12-1



B & R Automation-Heidenhain (BR-H3A8) -
Heidenhain EnDat 2.2, EQN 1135 Multi-turn Absolute Encoder, 23-bit,
Functional Safety – 8LS/8LM motor wiring w/M23 connectors

Power Connector Pin-Out		Pin Side View
Pin Number	Signal	
1	U	
2	PE	
3	W	
4	V	
A	PT1000	
B	PT1000	
C	Brake+	
D	Brake-	

Feedback Connector Pin-Out		Pin Side View
Pin Number	Signal	
1	12.5VDC	
2	D	
3	D/	
4	T	
5	T/	
6	-	
7	Com 1	
8	-	
9	-	
10	-	
11	-	
12	-	

Baldor-Heidenhain (BD-H1A1) - EnDat 2.2 Heidenhain
EQN1125 multi-turn absolute encoder – ED/EK motor wiring w/M23 connectors

Power Connector Pin-Out		Pin Side View
Pin Number	Signal	
1	T1	
2	Earth/Ground	
3	T3	
4	T2	
A	Thermal Switch	
B	Thermal Switch	
C	Brake+	
D	Brake-	

Feedback Connector Pin-Out		Pin Side View
Pin Number	Signal	
1	Data-	
2	Sin+	
3	0	
4	Cos+	
5	Clock-	
6	-	
7	Clock+	
8	Cos-	
9	5 volt	
10	DGND	
11	Sin-	
12	Data+	
Actuator Case	-	

Baldor-Resolver (BD-R1A1) -
Standard Resolver w/M23 connectors

Power Connector Pin-Out		Pin Side View
Pin Number	Signal	
1	U	
2	GND	
3	W	
4	V	
A	Therm	
B	Therm	
C	Brake+	
D	Brake-	

Feedback Connector Pin-Out		Pin Side View
Pin Number	Signal	
1	R1 Ref Hi	
2	R2 Ref Lo	
3	S1 Cos+	
4	S3 Cos-	
5	S2 Sin+	
6	S4 Sin-	
7	-	
8	-	
9	-	
10	-	
11	-	
12	-	
Actuator Case	Shield	

Baumuller-Resolver (BM-R1A1) -
Standard Resolver w/M23 connectors

Power Connector Pin-Out		Pin Side View
Pin Number	Signal	
1	Phase U	
2	PE	
3	Phase W	
4	Phase V	
A	Brake+	
B	Brake-	
C	-	
D	-	

Feedback Connector Pin-Out		Pin Side View
Pin Number	Signal	
1	Cos -	
2	-	
3	-	
4	-	
5	Sin -	
6	Sin +	
7	-	
8	Cos +	
9	-	
10	Ref +	
11	-	
12	Ref -	
Actuator Case	Shield	



Baumuelller-SICK (BM-S1A1) - SICK Hiperface SKM36
multi-turn absolute encoder – SH motor wiring w/M23 connectors

Power Connector Pin-Out		Pin Side View
Pin Number	Signal	
1	Phase U	
2	PE	
3	Phase V	
4	Phase W	
A	Brake+	
B	Brake-	
C	PT1000	
D	PT1000	

Feedback Connector Pin-Out		Pin Side View
Pin Number	Signal	
1	Ref Cos	
2	Daten +	
3	-	
4	-	
5	Sin	
6	Ref Sin	
7	Daten -	
8	Cos	
9	-	
10	GND	
11	-	
12	+V	
Actuator Case	-	

Beckhoff Automation-Heidenhain (BE-H1A2) -
EnDat 2.2 Heidenhain EQN1125 multi-turn absolute encoder –
AM3XXXX motor wiring w/M23 connectors

Power Connector Pin-Out		Pin Side View
Pin Number	Signal	
1	U	
2	PE	
3	W	
4	V	
A	Brake+	
B	Brake-	
C	PT1000	
D	PT1000	

Feedback Connector Pin-Out		Pin Side View
Pin Number	Signal	
1	B-	
2	0V voltage supply	
3	A-	
4	Up voltage supply	
5	Data	
6	-	
7	-	
8	Clock	
9	B+	
10	0V Sense	
11	A+	
12	Up Sense	
13	Data -	
14	-	
15	Clock -	
16	-	
17	-	
Actuator Case	-	

Baumuelller-Heidenhain (BM-H1A2) -
EnDat 2.2 Heidenhain EQN1125 multi-turn absolute encoder –
8LS/8LM motor wiring w/M23 connectors

Power Connector Pin-Out		Pin Side View
Pin Number	Signal	
1	Phase U	
2	PE	
3	Phase V	
4	Phase W	
A	Brake+	
B	Brake-	
C	-	
D	-	

Feedback Connector Pin-Out		Pin Side View
Pin Number	Signal	
1	Up Sense	
2	-	
3	-	
4	0V Sense	
5	PT1000	
6	PT1000	
7	Up voltage supply	
8	Clock	
9	Clock -	
10	0V voltage supply	
11	-	
12	B+	
13	B-	
14	Data	
15	A+	
16	A-	
17	Data -	
Actuator Case	-	

Beckhoff Automation-Heidenhain (BE-H3C2) -
EnDat 2.2 Heidenhain EQN1135 multi-turn absolute encoder –
23 bit, Functional Safety w/M23 connectors

Power Connector Pin-Out		Pin Side View
Pin Number	Signal	
A	U	
B	V	
C	W	
D	PE	
E	PT1000-	
F	Shield	
G	Brake+	
H	PT1000+	
L	Brake-	

Power cable: ZK4800-8023-xxxx
ZK4800-8024-xxxx

Feedback Connector Pin-Out		Pin Side View
Pin Number	Signal	
1	-	
2	GND	
3	-	
4	5 Vdc (±10%)	
5	Data; DX+ Data	
6	Us 11 Vdc	
7	-	
8	Clock; CLK+	
9	-	
10	GND sense	
11	-	
12	5V sense	
13	Data; DX-	
14	-	
15	Clock; CLK-	
16	-	
17	-	
Actuator Case	-	

Feedback Cable: ZK4810-8020-xxxx
ZK4810-8020-xxxx



Beckhoff Automation-SICK Absolute Encoder (BE-S4C0) – Hiperface DSL, EKM36 Multi-turn Absolute Encoder, 18-bit w/M23 connector

Power/Feedback Connector Pin-Out		Pin Side View
Pin Number	Signal	
A	U	
B	V	
C	W	
D	PE	
E	PT1000-/OCT-	
F	Shield	
G	Brake+	
H	PT1000+/OCT+	
L	Brake-	

Control Techniques-Encoder (CT-E1B2) - Standard Incremental Encoder – FM/HD motor wiring w/M23 connectors

Power Connector Pin-Out		Pin Side View
Pin Number	Signal	
1	R	
2	S	
¥	GND	
4	T	
5	Brake+	
6	Brake-	

Feedback Connector Pin-Out		Pin Side View
Pin Number	Signal	
1	Therm Switch	
2	Therm Switch	
3	-	
4	U	
5	U/	
6	V	
7	V/	
8	W	
9	W/	
10	A	
11	Z	
12	Z/	
13	A/	
14	B	
15	B/	
16	+ 5 VDC	
17	0V	
Actuator Case	-	

Mfg's Cable Part Number- S1BAAAXXX

Control Techniques-Resolver (CT-R2B1) - Standard Resolver – FM/HD motor wiring w/M23 connectors

Power Connector Pin-Out		Pin Side View
Pin Number	Signal	
1	R	
2	S	
¥	GND	
4	T	
5	Brake+	
6	Brake-	

Feedback Connector Pin-Out		Pin Side View
Pin Number	Signal	
1	Excitation High	
2	Excitation Low	
3	Cos High	
4	Cos Low	
5	Sin High	
6	Sin Low	
7	Therm Switch	
8	Therm Switch	
9	-	
10	-	
11	-	
12	-	
Actuator Case	Shield	

Mfg's Cable Part Number- SRBBBBXXXX / SRBBABXXXX

Control Techniques-SICK (CT-S1B1)– SICK Hiperface SKM36 multi-turn absolute encoder – FM/HD motor wiring w/M23 connectors

Power Connector Pin-Out		Pin Side View
Pin Number	Signal	
1	R	
2	S	
¥	GND	
4	T	
5	Brake+	
6	Brake-	

Feedback Connector Pin-Out		Pin Side View
Pin Number	Signal	
1	Ref Cos	
2	Daten +	
3	Daten -	
4	Cos	
5	Sin	
6	Ref Sin	
7	Therm Switch	
8	Therm Switch	
9	Screen	
10	Com	
11	-	
12	+V	
Actuator Case	-	

Mfg's Cable Part Number- SSB CABXXXX



Control Techniques-Heidenhain (CT-H1B2) -

EnDat 2.2 Heidenhain EQN1125 multi-turn absolute encoder Unidrive M75x w/ M23 connectors

Power Connector Pin-Out		Pin Side View
Pin Number	Signal	
1	R	
2	S	
¥	GND	
4	T	
5	Brake+	
6	Brake-	

Feedback Connector Pin-Out		Pin Side View
Pin Number	Signal	
1	PT1000	
2	PT1000	
3	-	
4	-	
5	-	
6	-	
7	-	
8	Clock +	
9	Clock -	
10	A+	
11	Data +	
12	Data -	
13	A-	
14	B+	
15	B-	
16	+ 5 VDC	
17	COM	
Actuator Case	Shield	

Elau-SICK (EU-S1A1) - SICK Hiperface SKM36 multi-turn absolute encoder - SH motor wiring w/M23 connectors

Power Connector Pin-Out		Pin Side View
Pin Number	Signal	
1	U (1)	
2	PE	
3	W (3)	
4	V (2)	
A	br+ (8)	
B	br- (7)	
C	PT1000	
D	PT1000	

Feedback Connector Pin-Out		Pin Side View
Pin Number	Signal	
1	REFCOS	
2	RS485+	
3	-	
4	-	
5	SIN	
6	REFSIN	
7	RS485-	
8	COS	
9	-	
10	GND	
11	-	
12	Us	
Actuator Case	-	

Mfg's Cable Part Number- SH Series Absolute Encoder Cable

Elmo-Resolver (EL-R1B1) - Standard Resolver w/M23 connectors

Power Connector Pin-Out		Pin Side View
Pin Number	Signal	
1	M1	
2	M3	
¥	PE	
4	Brake-	
5	M2	
6	Brake+	

Feedback Connector Pin-Out		Pin Side View
Pin Number	Signal	
1	-	
2	-	
3	Sin- S4	
4	Cos- S3	
5	Ref R2	
6	-	
7	Sin+ S2	
8	Cos+ S1	
9	Ref R1	
10	-	
11	-	
12	-	
Actuator Case	Shield	

Elmo-Encoder (EL-E1B2) - Standard Incremental Encoder w/M23 connectors

Power Connector Pin-Out		Pin Side View
Pin Number	Signal	
1	M1	
2	M3	
¥	PE	
4	Brake-	
5	M2	
6	Brake+	

Feedback Connector Pin-Out		Pin Side View
Pin Number	Signal	
1	Power Supply 5V	
2	Therm Switch	
3	Power Supply 0V	
4	HC+	
5	HC-	
6	HA+	
7	HA-	
8	HB+	
9	HB-	
10	A+	
11	A-	
12	B+	
13	B-	
14	Z+	
15	Z-	
16	-	
17	Therm Switch	
Actuator Case	-	

Elmo-Heidenhain (EL-H1B2) - EnDat 2.2 Heidenhain EQN1125 multi-turn absolute encoder w/M23 connectors

Power Connector Pin-Out		Pin Side View
Pin Number	Signal	
1	U	
2	W	
3	PE	
4	Brake-	
5	V	
6	Brake+	

Feedback Connector Pin-Out		Pin Side View
Pin Number	Signal	
1	B-	
2	0V voltage supply	
3	A-	
4	Up voltage supply	
5	Data	
6	-	
7	Therm Switch	
8	Clock	
9	B+	
10	0V Sense	
11	A+	
12	Up Sense	
13	Data -	
14	Therm Switch	
15	Clock -	
16	-	
17	-	
Actuator Case	-	

Exlar-Encoder (EX-E1A2) - Standard Incremental Encoder 2048 Line w/M23 connectors

Power Connector Pin-Out		Pin Side View
Pin Number	Signal	
1	R	
2	GND	
3	T	
4	S	
A	Brake+	AC (4): CBL-PWRB1-SMI-XXX DC (D): CBL-PWRB2-SMI-XXX
B	Brake-	
C	-	
D	-	

Feedback Connector Pin-Out		Pin Side View
Pin Number	Signal	
1	B-	
2	B	
3	A	
4	A-	
5	Z	
6	Z-	
7	GND	
8	Therm Switch	
9	Therm Switch	
10	+5VDC	
11	-	
12	W-	
13	V-	
14	U-	
15	W	
16	V	
17	U	
Actuator Case	-	

Exlar-Resolver (EX-R1A1) - Standard Resolver w/M23 connectors

Power Connector Pin-Out		Pin Side View
Pin Number	Signal	
1	R	
2	GND	
3	T	
4	S	
A	Brake+	
B	Brake-	
C	-	
D	-	

AC (4): CBL-PWRB1-SMI-XXX
DC (D): CBL-PWRB2-SMI-XXX

Feedback Connector Pin-Out		Pin Side View
Pin Number	Signal	
1	-	
2	Therm Switch	
3	- Cos	
4	- Sin	
5	- Exc	
6	Therm Switch	
7	+ Cos	
8	+ Sin	
9	+ Exc	
10	-	
11	-	
12	-	
Actuator Case	Shield	

CBL-RESOL-SMI-XXX

Exlar-SICK (EX-S1A2) - SICK Hiperface SKM36 multi-turn absolute encoder w/M23 connectors

Power Connector Pin-Out		Pin Side View
Pin Number	Signal	
1	R	
2	GND	
3	T	
4	S	
A	Brake+	AC (4): CBL-PWRB1-SMI-XXX DC (D): CBL-PWRB2-SMI-XXX
B	Brake-	
C	-	
D	-	

Feedback Connector Pin-Out		Pin Side View
Pin Number	Signal	
1	Sin +	
2	Com	
3	Cos +	
4	+5V	
5	Ref +	
6	-	
7	Therm Switch	
8	-	
9	Sin -	
10	-	
11	Cos -	
12	-	
13	Ref -	
14	Therm Switch	
15	-	
16	-	
17	-	
Actuator Case	-	

CBL-ABSOL-SMI-XXX



Exlar-Heidenhain (EX-H1A2) - EnDat 2.2 Heidenhain EQN1125 multi-turn absolute encoder w/M23 connectors

Power Connector Pin-Out		Pin Side View
Pin Number	Signal	
1	U	
2	PE	
3	W	
4	V	
A	Brake+	
B	Brake-	
C	-	
D	-	

AC (4): CBL-PWRB1-SMI-XXX
DC (D): CBL-PWRB2-SMI-XXX

Feedback Connector Pin-Out		Pin Side View
Pin Number	Signal	
1	B-	
2	0V voltage supply	
3	A-	
4	Up voltage supply	
5	Data+	
6	-	
7	Therm Switch	
8	Clock	
9	B	
10	0V Sense	
11	A	
12	Up Sense	
13	Data -	
14	Therm Switch	
15	Clock -	
16	-	
17	-	
Actuator Case	-	

CBL-ABSOL-SMI-XXX

Exlar-Encoder Flying Lead Cable (EX-E1Zx) - Standard Incremental Encoder 2048 lines with flying lead cable

Power Cable Signals	
Wire Color	Signal
Black-1	R
Green/Yellow	GND
Black-3	T
Black-2	S
Black-5	Brake+
Black-6	Brake-
White	PT1000
Blue	PT1000

Feedback Cable Signals	
Wire Color	Signal
Brown/Green	0V
White/Green	+5 VDC
Green	B
Yellow	B-
Blue	A
Red	A-
Violet	Z
Black	Z-
Red/Blue	U
Gray/Pink	U-
Pink	V-
White	W
Brown	W-
Brown (Large)	Therm Switch
White (Large)	Therm Switch

Exlar-Resolver Flying Lead Cable (EX-R1Zx) - Standard Resolver with flying lead cable

Power Cable Signals	
Wire Color	Signal
Black-1	R
Green/Yellow	GND
Black-3	T
Black-2	S
Black-5	Brake+
Black-6	Brake-
White	PT1000
Blue	PT1000

Feedback Cable Signals	
Wire Color	Signal
Green	Ref+ (R1)
Yellow	Ref-(R2)
Red	Sin+ (S1)
Violet	Cos+ (S2)
Orange	Sin- (S3)
Blue	Cos- (S4)
Brown	Therm Switch
Black	Therm Switch

Exlar-SICK Flying Lead Cable (EX-S1Zx) - SICK Hiperface SKM36 multi-turn absolute encoder with flying lead cable

Power Cable Signals	
Wire Color	Signal
Black-1	R
Green/Yellow	GND
Black-3	T
Black-2	S
Black-5	Brake+
Black-6	Brake-
White	PT1000
Blue	PT1000

Feedback Cable Signals	
Wire Color	Signal
Violet	+9 VDC
Black	Sine +
Brown	Sine -
Red	Cos +
Orange	Cos -
Blue	ECOM
Yellow	Data +
Green	Data -
Blue/White	Therm Switch
Yellow/White	Therm Switch



Exlar-Heidenhain Flying Lead Cable (EX-H1Zx) -
Heidenhain EnDat 2.1 EQN1125 multi-turn absolute encoder with flying lead cable

Power Cable Signals	
Wire Color	Signal
Black-1	R
Green/Yellow	GND
Black-3	T
Black-2	S
Black-5	Brake+
Black-6	Brake-
White	PT1000
Blue	PT1000

Feedback Cable Signals	
Wire Color	Signal
Green	A+
Yellow	A-
Blue	B+
Red	B-
Gray	Data+
Pink	Data-
Violet	Clock+
Black	Clock-
Brown	Up Sense
White	0V Sense
White/Green	COM
Brown (Large)	Therm Switch
White (Large)	Therm Switch

Infranor-SICK (IF-S1B2) - SICK Hiperface SKM36 multi-turn absolute encoder w/M23 connectors

Power Connector Pin-Out		Pin Side View
Pin Number	Signal	
1	R	
2	S	
¥	GND	
4	T	
5	Brake+	
6	Brake-	

Feedback Connector Pin-Out		Pin Side View
Pin Number	Signal	
1	Sin +	
2	Sin -	
3	Cos +	
4	Cos -	
5	Ref +	
6	Ref -	
7	-	
8	-	
9	-	
10	Com	
11	+ 5V	
12	PT1000	
13	PT1000	
14	-	
15	-	
16	-	
17	0	
Actuator Case	-	

Infranor-Resolver (IF-R1B2) - Standard Resolver w/M23 connectors

Power Connector Pin-Out		Pin Side View
Pin Number	Signal	
1	R	
2	S	
¥	GND	
4	T	
5	Brake+	
6	Brake-	

Feedback Connector Pin-Out		Pin Side View
Pin Number	Signal	
1	S2	
2	S4	
3	S3	
4	S1	
5	R1	
6	R2	
7	-	
8	-	
9	-	
10	-	
11	-	
12	Therm	
13	Therm	
14	-	
15	-	
16	-	
17	-	
Actuator Case	-	

Bosch-Rexroth-SICK (IN-S2D3)- SICK Hiperface multi-turn absolute encoder – MSK motor wiring w/M23 connectors

Power Connector Pin-Out		Pin Side View
Pin Number	Signal	
U1	Phase U	
V1	Phase V	
W1	Phase W	
PE	Earth	
5	PT1000	
6	PT1000	
7	Brake+	
8	Brake-	
9	-	

Feedback Connector Pin-Out		Pin Side View
Pin Number	Signal	
1	Vcc_Encoder	
2	GND_Encoder	
3	A+	
4	A-	
5	B+	
6	B-	
7	EncData+	
8	EncData-	
9	-	
10	-	

Mfg's Cable Part Number-
RKG4200

Bosch-Rexroth-Heidenhain (IN-H1D3)- EnDat Heidenhain
EQN1125 multi-turn absolute InDrive wiring w/M23 connectors

Power Connector Pin-Out		Pin Side View
Pin Number	Signal	
U1	Phase U	
V1	Phase V	
W1	Phase W	
PE	Earth	
5	PT1000	
6	PT1000	
7	Brake+	
8	Brake-	
9	-	

Feedback Connector Pin-Out		Pin Side View
Pin Number	Signal	
1	Vcc_Encoder	
2	GND_Encoder	
3	A+	
4	A-	
5	B+	
6	B-	
7	Data +	
8	Data -	
9	Clock	
10	Clock -	

Kollmorgen-Encoder (KM-E1A2) -
Standard Incremental Encoder – AKM motor wiring w/ M23 connectors

Power Connector Pin-Out		Pin Side View
Pin Number	Signal	
1	U	
2	PE	
3	W	
4	V	
A	Brake+	
B	Brake-	
C	-	
D	-	

Feedback Connector Pin-Out		Pin Side View
Pin Number	Signal	
1	B+	
2	B-	
3	A+	
4	A-	
5	Z	
6	Z-	
7	GND	
8	Therm Switch	
9	Therm Switch	
10	Vcc	
11	-	
12	U-	
13	V-	
14	W-	
15	U	
16	V	
17	W	
Actuator Case	-	

Mfg's Cable Part Number-
CF-CB7374N-XX

Kollmorgen-Resolver (KM-R2A1) - Standard Resolver – AKM
motor wiring w/M23 connectors

Power Connector Pin-Out		Pin Side View
Pin Number	Signal	
1	U	
2	GND	
3	W	
4	V	
A	Brake+	
B	Brake-	
C	-	
D	-	

Feedback Connector Pin-Out		Pin Side View
Pin Number	Signal	
1	-	
2	Therm Switch	
3	Cos Lo (S4)	
4	Sin Lo (S3)	
5	Ref Lo (R2)	
6	Therm Switch	
7	Cos Hi (S2)	
8	Sin Hi (S1)	
9	Ref Hi (R1)	
10	-	
11	-	
12	-	
Actuator Case	Shield	

Mfg's Cable Part Number-
VF-RA2474N-XX

LTI-Resolver (LS-R2A1) - Standard Resolver – AKM motor wiring
w/M23 connectors

Power Connector Pin-Out		Pin Side View
Pin Number	Signal	
1	U	
2	GND	
3	W	
4	V	
A	Brake+	
B	Brake-	
C	-	
D	-	

Feedback Connector Pin-Out		Pin Side View
Pin Number	Signal	
1	(S1) Cos +	
2	(S3) Cos -	
3	(S2) Sin +	
4	(S4) Sin -	
5	-	
6	(R1) Ref +	
7	(R2) Ref -	
8	-	
9	-	
10	-	
11	PT1000+	
12	PT1000-	
Actuator Case	-	

LTI-SICK (LS-S1A2) - SICK Hiperface SKM36 multi-turn absolute encoder w/M23 connectors

Power Connector Pin-Out		Pin Side View
Pin Number	Signal	
1	Phase U	
2	Protective Earth	
3	Phase W	
4	Phase V	
A	Brake+	
B	Brake-	
C	PT1000	
D	PT1000	

Feedback Connector Pin-Out		Pin Side View
Pin Number	Signal	
1	COS+	
2	REFCOS	
3	SIN+	
4	REFSIN	
5	-	
6	-	
7	GND	
8	-	
9	Us 7-12v	
10	Dataen+ RS485	
11	Dataen- RS485	
12	-	
13	-	
14	-	
15	-	
16	-	
17	-	
Actuator Case	-	

Lenze-Encoder (LZ-S1B1) - SICK Hiperface SKM36 multi-turn absolute encoder w/M23 connectors

Power Connector Pin-Out		Pin Side View
Pin Number	Signal	
1	Y1 / BD1	
2	Y2 / BD2	
3	PI	
4	U	
5	V	
6	W	

Feedback Connector Pin-Out		Pin Side View
Pin Number	Signal	
1	+ SIN	
2	- COS	
3	+ COS	
4	+ 8 V	
5	Mass	
6	- RS485	
7	+ RS485	
8	-	
9	- SIN	
10	-	
11	PT1000	
12	PT1000	
Actuator Case	-	

Mfg's Cable Part Number-
MCS Series Absolute Encoder
Cable

Parker-Resolver (PC-R1B1) - Standard Resolver – SMH motor wiring w/M23 connectors

Power Connector Pin-Out		Pin Side View
Pin Number	Signal	
1	U	
2	V	
3	PE	
4	Brake+	
5	Brake-	
6	W	

Feedback Connector Pin-Out		Pin Side View
Pin Number	Signal	
1	Sin -	
2	Sin +	
3	-	
4	-	
5	-	
6	-	
7	Ref -	
8	PT1000	
9	PT1000	
10	Ref +	
11	Cos +	
12	Cos -	
Actuator Case	Shield	

Mfg's Cable Part Number-
SMH Series Incremental
Encoder Cable

Lenze-Resolver (LZ-R1B1) - Standard Resolver – MCS motor wiring w/M23 connectors

Power Connector Pin-Out		Pin Side View
Pin Number	Signal	
1	Y1 / BD1	
2	Y2 / BD2	
3	PI	
4	U	
5	V	
6	W	

Feedback Connector Pin-Out		Pin Side View
Pin Number	Signal	
1	+ Ref	
2	- Ref	
3	-	
4	+ Cos	
5	- Cos	
6	+ Sin	
7	- Sin	
8	-	
9	-	
10	-	
11	PT1000	
12	PT1000	
Actuator Case	-	

Mfg's Cable Part Number-
MCS Series Resolver Cable



Parker-Encoder (PC-E1B2) - Standard Incremental Encoder - MPP series motor wiring w/M23 connectors

Power Connector Pin-Out		Pin Side View
Pin Number	Signal	
1	U	
2	W	
4	PE	
4	Brake+	
5	Brake-	
6	V	

Feedback Connector Pin-Out		Pin Side View
Pin Number	Signal	
1	A-	
2	A+	
3	-	
4	Hall 1	
5	Hall 3	
6	Hall 2	
7	Ground	
8	+5 vdc	
9	Therm Switch	
10	-	
11	B	
12	B-	
13	Therm Switch	
14	-	
15	Z+	
16	Z-	
17	-	

Mfg's Cable Part Number- SMH Series Resolver Cable

Rockwell Automation-Encoder (RA-E1C2) - Standard Incremental Encoder - MPL Type M feedback w/M23 connectors

Power Connector Pin-Out		Pin Side View
Pin Number	Signal	
A	Phase U	
B	Phase V	
C	Phase W	
D	Ground	
E	-	
F	Brake+	
G	Brake-	
H	-	
L	-	

See Below*

Feedback Connector Pin-Out		Pin Side View
Pin Number	Signal	
1	A(+)	
2	A(-)	
3	B(+)	
4	B(-)	
5	I(+)	
6	I(-)	
7	-	
8	-	
9	EPWR_5V	
10	Common	
11	-	
12	-	
13	Therm Switch	
14	Therm Switch	
15	S1	
16	S2	
17	S3	
Actuator Case	-	

Mfg's Cable Part Number- 2090-CFBM7DF-CDAxyy

*GTX060 & GTX080:
2090-CPBM7DF-16Axyy
GTX100: 2090-CPBM7DF-14Axyy

Parker-Heidenhain (PC-H1B2) -

EnDat 2.2 Heidenhain EQN1125 multi-turn absolute encoder w/M23 connectors

Power Connector Pin-Out		Pin Side View
Pin Number	Signal	
1	U	
2	V	
4	GND	
4	Brake+	
5	Brake-	
6	W	

Feedback Connector Pin-Out		Pin Side View
Pin Number	Signal	
1	CH A-	
2	CH A+	
3	-	
4	CLK +	
5	CLK -	
6	-	
7	Ground	
8	Vcc	
9	Therm	
10	-	
11	CH B+	
12	CH B-	
13	Therm	
14	Up	
15	Data +	
16	Data -	
17	-	
Actuator Case	-	

Rockwell Automation-SICK Absolute DSL Encoder (RA-S3C0) - Hiperface, EKM36 multi-turn absolute encoder w/M23 connectors

Power Connector Pin-Out		Pin Side View
Pin Number	Signal	
A	Phase U	
B	Phase V	
C	Phase W	
D	Ground	
E	Data +	
F	Brake+	
G	Brake-	
H	Data -	
L	-	

Mfg's Cable Part Number- 2090-CSBM1DE-14AA05

Rockwell Automation-SICK (RA-S1C2) -

Hiperface, SKM36 multi-turn absolute encoder. MPL Type V feedback (128 sin/cos) / M23 connectors¹

Power Connector Pin-Out		Pin Side View
Pin Number	Signal	
A	Phase U	
B	Phase V	
C	Phase W	
D	Ground	
E	-	
F	Brake+	
G	Brake-	
H	-	
L	-	

See Below*

Feedback Connector Pin-Out		Pin Side View
Pin Number	Signal	
1	Sine +	
2	Sine -	
3	Cos +	
4	Cos -	
5	Data +	
6	Data -	
7	-	
8	-	
9	-	
10	ECOM	
11	+ 9 vdc	
12	-	
13	Therm Switch	
14	Therm Switch	
15	-	
16	-	
17	-	
Actuator Case	-	

Mfg's Cable Part Number-
2090-CFBM7DF-CDAXxy

1. Not compatible with Kinetix 300 Drives.

*GTX060 & GTX080:
2090-CPBM7DF-16Axyy
GTX100: 2090-CPBM7DF-14Axyy

Siemens-Heidenhain (SM-H1B2) -

EnDat 2.2 Heidenhain EQN1125 multi-turn absolute encoder – 1FK7 motor wiring w/M23 connectors

Power Connector Pin-Out		Pin Side View
Pin Number	Signal	
1	U	
2	V	
3	GNYE	
4	BD1+	
5	BD2-	
6	W	

See Below*

Feedback Connector Pin-Out		Pin Side View
Pin Number	Signal	
1	A+	
2	A-	
3	+ data	
4	-	
5	+clock	
6	-	
7	M-Encoder	
8	PT1000	
9	PT1000	
10	P-Encoder	
11	B+	
12	B-	
13	- data	
14	-clock	
15	0 V Sense	
16	5 V Sense	
17	-	
Actuator Case	-	

Mfg's Cable Part Number-
6FX.002-2DC36-....

*GTX060 & GTX080:
6FX5002-5DA01-...
GTX100: 6FX5002-5DA11-....

Siemens-Resolver (SM-R1B1) -

Standard Resolver – 1FK7 motor wiring w/M23 connectors

Power Connector Pin-Out		Pin Side View
Pin Number	Signal	
1	U	
2	V	
3	GNYE	
4	BD1+	
5	BD2-	
6	W	

See Below*

Feedback Connector Pin-Out		Pin Side View
Pin Number	Signal	
1	SIN	
2	*SIN	
3	-	
4	-	
5	-	
6	Shield	
7	-Vpp	
8	PT1000	
9	PT1000	
10	+Vpp	
11	COS	
12	*COS	
Actuator Case	Shield	

Mfg's Cable Part Number-
6FX5002-2CF02-....

*GTX060 & GTX080:
6FX5002-5DA01-...
GTX100: 6FX5002-5DA11-....

Stober-Resolver (SB-R4A1) -

Standard Resolver ED/EK motor wiring w/M23 connector

Power Connector Pin-Out		Pin Side View
Pin Number	Signal	
1	U	
2	GND	
3	V	
4	W	
A	Brake	
B	Brake	
C	Therm Switch	
D	Therm Switch	

Feedback Connector Pin-Out		Pin Side View
Pin Number	Signal	
1	Sin + (S4)	
2	Sin - (S2)	
3	Cos + (S3)	
4	Cos - (S1)	
5	-	
6	-	
7	Erreg+ (R2)	
8	Erreg- (R1)	
9	-	
10	-	
11	-	
12	-	
Actuator Case	-	

Stober-Heidenhain (SB-H1A1) - EnDat 2.2 Heidenhain
 EQN1125 multi-turn absolute encoder – ED/EK motor wiring w/M23 connectors

Power Connector Pin-Out		Pin Side View
Pin Number	Signal	
1	U	
2	GND	
3	S	
4	T	
A	Brake	
B	Brake	
C	Therm Switch	
D	Therm Switch	

Feedback Connector Pin-Out		Pin Side View
Pin Number	Signal	
1	Clock +	
2	Up Sense	
3	-	
4	-	
5	Data -	
6	Data	
7	-	
8	Clock -	
9	-	
10	0V	
11	-	
12	Up	
Actuator Case	-	

Mfg's Cable Part Number-
 Stober Absolute Encoder
 Cable



Ordering Information



For options or specials not listed above or for extended temperature operation, please contact Exlar

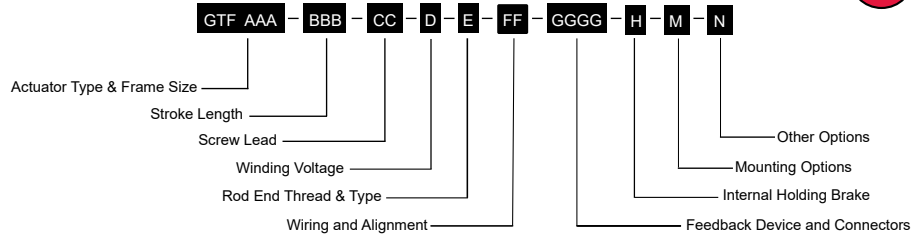

AAA = GTF Integrated Motor / Actuator

- 060 = 60 mm (2.36 in)
- 080 = 80 mm (3.15 in)
- 100 = 100 mm (3.94 in)

BBB = Standard Stroke Length¹

GTF060	GTF080	GTF100
80 mm	-	-
-	100 mm	-
150 mm	150 mm	150 mm
300 mm	300 mm	300 mm
-	450 mm	-

CC = Roller Screw Lead

- 01 = 2.54 mm (0.1 in)
- 02 = 5.08 mm (0.2 in)
- 04 = 10.2 mm (0.4 in), (GTF060)
- 05 = 12.7 mm (0.5 in), (GTF080, GTF100)

D = Winding Voltage

- 4 = 460 VAC Max

E = Rod End Thread & Type

- L = Female Metric, 17-4 Stainless Steel
- R = Male Metric, 17-4 Stainless Steel
- V = Female Imperial, 17-4 Stainless Steel
- W = Male Imperial, 17-4 Stainless Steel

FF = Wiring and Alignment

See table below

GGGG = Feedback Device and Connectors

See table below

H = Internal Holding Brake

- N = No Brake
- B = Internal Holding Brake, Electronically Released

M = Mounting Options

- N = Hygienic Tapped Face Mount, with Face Gasket and Shaft Seal

- 4 = Stainless Steel Front Flange, Hygienic Metric (ISO MF1)
- G = Stainless Steel Front Flange, Hygienic Imperial
- 7 = Hygienic Face Cover with Metric (ISO MP2) Stainless Steel Rear Clevis
- H = Hygienic Face Cover with Imperial Stainless Steel Rear Clevis

N = Other Options

- N = None
- A = Stainless Steel Anti-Rotate Assembly

NOTES:

¹ Non-Imperial stroke lengths available in 25 mm increments. Extended lead-times may apply

Drive / Feedback Designator Callouts

Drive Manufacturers	Wiring & Alignment Code	Resolver	Incremental Encoder	SICK Hiperface Absolute Encoder	SICK Hiperface DSL Absolute Encoder	Heidenhain Endat 2.1 Absolute Encoder ¹	Heidenhain Endat 2.2 Absolute Encoder ²
AMK	AK	R1A1				H1A1	
B&R Automation	BR	R1A1				H1A2	H3A8 ³
Baldor	BD	R1A1				H1A1	
Baumuller	BM	R1A1		S1A1		H1A2	
Beckhoff Automation	BE				S4C0 ³	H1A2	H3C2 ³
Control Technologies / Nidec	CT	R2B1	E1B2	S1B1		H1B2	
Elau / Schneider	EU			S1A1 ⁴			
Elmo Motion Control	EL	R1B1	E1B2			H1B2	
Curtiss-Wright Exlar	EX	R1A1	E1A2	S1A2		H1A2	
Curtiss-Wright Exlar Flying Lead Cables	EX	R1Zx ⁵	E1Zx ⁵	S1Zx ⁵		H1Zx ⁵	
Infranor	IF	R1B2		S1B2			
Bosch-Rexroth	IN			S2D3 ⁴		H1D3	
Kollmorgen	KM	R2A1	E1A2			H1A2	
LTI	LS	R2A1		S1A2			
Lenze	LZ	R1B1		S1B1			
Parker	PC	R1B1	E1B2			H1B2	
Rockwell Automation	RA		E1C2	S1C2 ⁴	S3C0 ⁴		
Rockwell Automation Extension Cable with Connector	RA				S3Kx ^{4,5}		
Siemens	SM	R1B1				H1B2	
Stober Drives	SB	R4A1				H1A1	

¹Synchronous serial EnDat 2.1 with 1 Vpp Incremental Signals (EnDat01)

²Synchronous serial EnDat 2.2 without Incremental Signals (EnDat22)

³Supports Functional Safety

⁴Encoder is pre-programmed for operation with the manufacturer's servo drives.

⁵x=Refer to length options in feedback and connector tables below



Warranty and Limitations of Liability

WARRANTY AND LIMITATION OF LIABILITY: Please see our warranty on our website here: <https://www.cw-actuation.com/en-gb/about/terms-conditions> for details.

Exlar

Curtiss-Wright

18400 West 77th Street

Chanhassen, MN 55317

Phone: 855-620-6200 (US & Canada)

Fax: 952-368-4877

Distributed by:

EXLAR[®]

cw-actuation.com

Exlar[®] actuators are a brand of Curtiss-Wright, Actuation Division.